

**Integrating the Healthcare Enterprise**



5

**IHE IT Infrastructure  
Technical Framework**

**Volume 2x**

**IHE ITI TF-2x**

10

**Volume 2 Appendices**

15

20

**Revision 17.0 – Final Text**

**July 20, 2020**

25

Please verify you have the most recent version of this document, which is published [here](#).

## CONTENTS

30	Appendix A: Web Service Definition for Retrieve Specific Information for Display and Retrieve Document for Display Transaction.....	6
	Appendix B: Definition of Unique Ids.....	14
	B.1 Requirements for UIDs.....	14
	B.2 Structure of a UID.....	14
35	B.3 UID encoding rules.....	15
	B.4 How to obtain a UID registration root? .....	15
	B.5 Example of a UID .....	15
	B.6 Representing UUIDs as OIDs.....	16
	Appendix C: HL7 Profiling Conventions .....	17
40	C.1 HL7 Message Profiling Convention .....	18
	C.1.1 Static definition - Message level.....	18
	C.1.2 Static definition – Segment level and Data Type level.....	19
	C.2 HL7 Implementation Notes.....	20
	C.2.1 Network Guidelines .....	20
45	C.2.2 Message Control .....	20
	C.2.3 Acknowledgment Modes .....	22
	C.2.4 Common Segment Definitions .....	25
	C.2.5 Message granularity.....	26
	C.2.6 HL7 empty field convention.....	26
50	Appendix D: Cross-Profile Interactions of PIX and PSA .....	27
	D.1 Namespace Translation from PIX Query to CCOW.....	28
	D.2 Processing Multiple Identifiers.....	29
	Appendix E: Patient Identifiers in HL7-based IHE Profiles.....	31
	E.1 Patient Identifier Cross-reference Manager Actor Requirements.....	32
55	E.1.1 Other actor requirements .....	33
	E.1.2 Examples of use .....	34
	E.1.3 Data sent by source systems .....	34
	E.1.4 Data sent by the Patient Identifier Cross-reference Manager .....	35
	E.2 HL7 V3 II Data Type.....	36
60	E.2.1 Patient Identifier Cross-reference Manager requirements.....	37
	E.2.2 Other actor requirements .....	38
	E.2.3 Examples of use.....	38
	Appendix F: Character String Comparisons.....	41
	Appendix G: Intentionally Left Blank .....	42
65	Appendix H: Intentionally Left Blank .....	42
	Appendix I: Intentionally Left Blank .....	42
	Appendix J: Intentionally Left Blank .....	42
	Appendix K: XDS Security Environment.....	43
	K.1 Security Environment .....	43
70	K.1.1 Threats .....	43

	K.1.2 Security and Privacy Policy.....	45
	K.1.3 Security Usage Assumptions.....	46
	K.2 Security Objectives.....	46
	K.2.1 XDS Component Security Objectives.....	46
75	K.2.2 Environment Security Objectives.....	48
	K.3 Functional Environment.....	48
	Appendix L: Relationship of Document Entry Attributes and Document Headers.....	51
	Appendix M: Using Patient Demographics Query in a Multi-Domain Environment.....	52
	M.1 HL7 QBP^Q22 Conformance Model.....	52
80	M.2 IHE PDQ Architecture.....	52
	M.3 Implementing PDQ in a multi-domain architecture.....	53
	Appendix N: Common Data Types.....	55
	N.1 CX Data Type.....	55
	N.2 EI Data Type.....	55
85	N.3 HD Data Type.....	56
	N.4 PL data Type.....	56
	N.5 TS Data Type.....	58
	N.6 XPN Data Type.....	58
	Appendix O: HL7 v3 Transmission and Trigger Event Control Act Wrappers.....	60
90	O.1 HL7 V3 Transmission Wrappers.....	60
	O.1.1 Send Message Payload Information Model (MCCI_RM000100IHE).....	60
	O.1.2 Send Accept Acknowledgement Information Model (MCCI_RM000200IHE).....	63
	O.1.3 Send Application Acknowledgement Information Model (MCCI_RM000300IHE).....	67
	O.2 HL7 V3 Transmission Content.....	70
95	O.2.1 Master File/Registry Event Notification Control Act (Role Subject) Information Model (MFMI_MT700701IHE).....	71
	O.2.2 Master File/Registry Query Response Control Act (Role Subject) Information Model (MFMI_MT700711IHE).....	74
	O.2.3 Query Control Act Request: Query By Parameter Information Model (QUQI_MT021001IHE).....	78
100	O.2.4 Query Control Act Request Continue/Cancel Information Model (QUQI_MT000001IHE).....	80
	O.3 IHE Transactions and Corresponding Transmission and Control Act Wrappers.....	82
	Appendix P: Examples of messages.....	83
105	P.1 Example of Admit for Surgical Procedure, [ITI-31] Transaction.....	83
	P.1.1 Storyboard.....	83
	P.1.2 Interaction Diagram.....	84
	P.1.3 Messages.....	86
	P.2 Example of Admit and cancel admit, [ITI-31] Transaction.....	89
110	P.2.1 Storyboard.....	89
	P.2.2 Interaction Diagram.....	90
	P.2.3 Messages.....	91
	P.3 HL7 V3 Sample Messages.....	91
	P.3.1 ITI-44 Patient Identity Feed HL7 V3 – Sample Messages.....	91
115	P.3.2 ITI-45 PIXV3 Query – Sample Messages.....	92

	P.3.3 ITI-46 PIXV3 Update Notification – Sample Messages .....	92
	P.3.4 ITI-47 Patient Demographics Query HL7 V3 – Sample Messages.....	92
	Appendix Q: HL7 V3 Sample Payload XML Schemas .....	93
120	Q.1 ITI-44 Patient Identity Feed HL7 V3 – Sample Schemas .....	93
	Q.2 ITI-45 PIXV3 Query – Sample Schemas.....	93
	Q.3 ITI-46 PIXV3 Update Notification – Sample Schemas.....	93
	Q.4 ITI-47 Patient Demographics Query HL7 V3 – Sample Schemas .....	93
	Appendix R: Mapping of HL7v2.5 to HL7v3 for PIX and PDQ.....	94
	R.1 Data Types .....	94
125	R.2 Add New Person Message .....	96
	Appendix S: Intentionally Left Blank .....	118
	Appendix T: Use of eMail (Informative).....	119
	Appendix U: Intentionally Left Blank .....	122
	Appendix V: Web Services for IHE Transactions .....	123
130	V.1 Introduction.....	123
	V.2 Relevant Standards.....	123
	V.2.1 WS-I Profiles .....	123
	V.2.2 WS-* Specifications .....	123
	V.2.3 HL7 Web Services Profile .....	124
135	V.2.4 XML Namespaces .....	124
	V.3 Web Services Requirements .....	124
	V.3.1 Requirements for Transactions using HL7 V3 Messages.....	125
	V.3.2 Requirements for Transactions which don’t use HL7 V3 Messages.....	126
	V.4 Web Services for specific IHE Transactions .....	133
140	V.5 Synchronous and Asynchronous Web Services Exchange.....	134
	V.5.1 Overview.....	134
	V.5.2 Considerations for using Asynchronous Web Services Exchange .....	134
	V.5.3 Specification of the use of Asynchronous Web Services Exchange .....	135
	V.6 Web Services Standards Evolution.....	135
145	V.7 Web Services References.....	135
	V.8 Usage of MTOM/XOP .....	136
	V.8.1 Simple SOAP vs MTOM .....	136
	V.8.2 Use of MTOM encoding .....	136
	V.8.3 Use of XOP Optimization (Informative).....	137
150	V.9 Sample SOAP Messages .....	137
	V.9.1 Simple SOAP .....	137
	V.9.2 SOAP Headers.....	137
	V.9.3 MTOM/XOP .....	138
	V.9.4 Full Sample.....	141
155	Appendix W: Implementation Material .....	142
	Appendix X: Basic Unstructured Workflow Definition Example.....	142
	X.1 Workflow definition identifier .....	142
	X.2 Workflow definition identifier .....	142
	X.3 Workflow opening and closing.....	143
160	X.4 Tasks descriptions .....	143

X.4.1 Task type “born completed” .....	143
X.4.2 Task type “two states task” .....	143
GLOSSARY .....	145

## Appendix A: Web Service Definition for Retrieve Specific Information for Display and Retrieve Document for Display Transaction

170 The following is an example WSDL definition of web services used in transactions [ITI-11] and  
 [ITI-12]. This code is provided as an example and is not intended to replace the formal  
 specification of transactions [ITI-11] and [ITI-12] in Volume 2a. Also, the definitions of  
 summaryRequestType, listRequestType and contentType shall correspond to the capabilities of  
 175 the Information Source.

```

175 <?xml version="1.0" encoding="utf8"?>

180 <definitions xmlns:http="http://schemas.xmlsoap.org/wsdl/http/"
  xmlns:s="http://www.w3.org/2001/XMLSchema"
  xmlns:s0="http://rsna.org/ihe/IHERetrieveForDisplay"
  xmlns:tm="http://microsoft.com/wsdl/mime/textMatching/"
  xmlns:mime="http://schemas.xmlsoap.org/wsdl/mime/"
  targetNamespace="http://rsna.org/ihe/IHERetrieveForDisplay"
  xmlns="http://schemas.xmlsoap.org/wsdl/">

185   <!-- Defines the types available for the parameters -->
   <!-- May also include the return type definitions -->
   <types>
     <s:schema elementFormDefault="qualified"
190     targetNamespace="http://rsna.org/ihe/IHERetrieveForDisplay">
       <!-- Add any items that control the returned values list or type here -
       ->
       <!-- Add or remove items in the actual supplied WSDL to show the
195     available types. -->
       <s:simpleType name="summaryRequestType">
         <s:restriction base="s:string">
           <s:enumeration value="SUMMARY" />
           <s:enumeration value="SUMMARY-RADIOLOGY" />
           <s:enumeration value="SUMMARY-CARDIOLOGY" />
200           <s:enumeration value="SUMMARY-LABORATORY" />
           <s:enumeration value="SUMMARY-SURGERY" />
           <s:enumeration value="SUMMARY-EMERGENCY" />
           <s:enumeration value="SUMMARY-DISCHARGE" />
           <s:enumeration value="SUMMARY-ICU" />
205         </s:restriction>
       </s:simpleType>

       <s:simpleType name="listRequestType">
210         <s:restriction base="s:string">
           <s:enumeration value="LIST-ALLERGIES" />
           <s:enumeration value="LIST-MEDS" />
         </s:restriction>
       </s:simpleType>

215   <!-- Please list all content types available, and remove those not
   available. -->
   <s:simpleType name="contentType">
     <s:restriction base="s:string">

```

```
220     <s:enumeration value="text/html" />
    </s:restriction>
  </s:simpleType>

  <!-- Indicates that this item is a returned rows restriction -->
225  <s:simpleType name="ReturnedResultCount" type="s:positiveInteger" />

  <!-- Please use the string "Search" as a prefix for all search
criteria, and list below -->
  <!-- Indicates that this item is a search string -->
230  <s:simpleType name="SearchString" type="s:string" />

  </s:schema>
235 </types>

  <message name="RetrieveSummaryInfoHttpGetIn">
    <!-- Add other parameters here if they are available, using types defined
above. -->
240    <part name="requestType" type="summaryRequestType" />
    <part name="patientID" type="SearchString" />
    <part name="lowerDateTime" type="s:dateTime" />
    <part name="upperDateTime" type="s:dateTime" />
    <part name="mostRecentResults" type="ReturnedResultCount" />
  </message>

245  <message name="RetrieveSummaryInfoHttpGetOut">
    <!-- If a complex type is defined for the return value, then it is
suggested that -->
    <!-- it be used here instead of s0:string. If a complex type is allowed
250 as one -->
    <!-- of the options, but an arbitrarily formatted string is also allowed,
then create -->
    <!-- a union type here that allows either option. -->
    <part name="Body" element="s0:string" />
255  </message>

  <message name="RetrieveListInfoHttpGetIn">
    <!-- Add other parameters here if they are available, using types defined
above. -->
260    <part name="requestType" type="listRequestType" />
    <part name="patientID" type="SearchString" />
  </message>

  <message name="RetrieveListInfoHttpGetOut">
265    <!-- If a complex type is defined for the return value, then it is
suggested that -->
    <!-- it be used here instead of s0:string. If a complex type is allowed
as one -->
    <!-- of the options, but an arbitrarily formatted string is also allowed,
270 then create -->
    <!-- a union type here that allows either option. -->
    <part name="Body" element="s0:string" />
  </message>
```

```
275 <message name="RetrieveDocumentHttpGetIn">
  <!-- Add other parameters here if they are available, using types defined
  above. -->

  <!-- It is recommended that one of the sub-types of SearchUID is chosen
  here -->
280 <!-- Especially if SearchStudyUID is allowed, then the display client can
  know that -->
  <!-- it is permissible to use a dicom uid here -->
  <part name="documentUID" type="SearchString" />
  <part name="contentType" type="contentType" />
285 </message>

  <message name="RetrieveDocumentHttpGetOut">
  <!-- If a complex type is defined for the return value, then it is
  suggested that -->
290 <!-- it be used here instead of s:string. If a complex type is allowed as
  one -->
  <!-- of the options, but an arbitrarily formatted string is also allowed,
  then create -->
  <!-- a union type here that allows either option. -->
295 <part name="Body" element="s:string" />
  </message>

  <portType name="IHERetrieveForDisplayHttpGet">
  <operation name="RetrieveSummaryInfo">
300 <input message="s0:RetrieveSummaryInfoHttpGetIn" />
  <output message="s0:RetrieveSummaryInfoHttpGetOut" />
  </operation>
  <operation name="RetrieveListInfo">
305 <input message="s0:RetrieveListInfoHttpGetIn" />
  <output message="s0:RetrieveListInfoHttpGetOut" />
  </operation>
  <operation name="RetrieveDocument">
310 <input message="s0:RetrieveDocumentHttpGetIn" />
  <output message="s0:RetrieveDocumentHttpGetOut" />
  </operation>
  </portType>

  <binding name="IHERetrieveForDisplayHttpGet"
315 type="s0:IHERetrieveForDisplayHttpGet">
  <http:binding verb="GET" />
  <operation name="RetrieveSummaryInfo">
  <http:operation location="/IHERetrieveSummaryInfo" />
  <input>
320 <http:urlEncoded />
  </input>

  <output>
  <mime:content type="text/html" />
  </output>
325 </operation>

  <operation name="RetrieveListInfo">
  <http:operation location="/IHERetrieveListInfo" />
```



```

330     <input>
        <http:urlEncoded />
    </input>

    <output>
335     <mime:content type="text/html" />
    </output>
</operation>

<operation name="RetrieveDocument">
340     <http:operation location="/IHERetrieveDocument" />
    <input>
        <http:urlEncoded />
    </input>

    <!-- The type of the output should be restricted on a per-server basis
345 to the types -->
    <!-- actually provided. -->
    <output>
        <mime:content type="text/html" />
350     <mime:content type="application/x-hl7-cda-level-one+xml" />
        <mime:content type="application/pdf" />
        <mime:content type="image/jpeg" />
    </output>
    </operation>
</binding>
355

<!-- Bind the actual service here -->
<service name="IHERetrieveForDisplay">
    <port name="IHERetrieveForDisplayHttpGet"
360 binding="s0:IHERetrieveForDisplayHttpGet">
        <http:address location="http://localhost/" />
    </port>
</service>
<?xml version="1.0" encoding="utf8"?>
365 <definitions xmlns:http="http://schemas.xmlsoap.org/wsdl/http/"
    xmlns:s="http://www.w3.org/2001/XMLSchema"
    xmlns:s0="http://rsna.org/ihe/IHERetrieveForDisplay"
    xmlns:tm="http://microsoft.com/wsdl/mime/textMatching/"
    xmlns:mime="http://schemas.xmlsoap.org/wsdl/mime/"
370 targetNamespace="http://rsna.org/ihe/IHERetrieveForDisplay"
    xmlns="http://schemas.xmlsoap.org/wsdl/">

    <!-- Defines the types available for the parameters -->
    <!-- May also include the return type definitions -->
375 <types>
        <s:schema elementFormDefault="qualified"
            targetNamespace="http://rsna.org/ihe/IHERetrieveForDisplay">
            <!-- Add any items that control the returned values list or type here -
->
380 <!-- Add or remove items in the actual supplied WSDL to show the
            available types. -->
            <s:simpleType name="summaryRequestType">
                <s:restriction base="s:string">

```

```
385     <s:enumeration value="SUMMARY" />
    <s:enumeration value="SUMMARY-RADIOLOGY" />
    <s:enumeration value="SUMMARY-CARDIOLOGY" />
    <s:enumeration value="SUMMARY-LABORATORY" />
    <s:enumeration value="SUMMARY-SURGERY" />
390     <s:enumeration value="SUMMARY-EMERGENCY" />
    <s:enumeration value="SUMMARY-DISCHARGE" />
    <s:enumeration value="SUMMARY-ICU" />
    <s:enumeration value="SUMMARY-RX" />
  </s:restriction>
</s:simpleType>
395
  <s:simpleType name="listRequestType">
    <s:restriction base="s:string">
      <s:enumeration value="LIST-ALLERGIES" />
400      <s:enumeration value="LIST-MEDS" />
    </s:restriction>
  </s:simpleType>

  <!-- Please list all content types available, and remove those not
405 available. -->
  <s:simpleType name="contentType">
    <s:restriction base="s:string">
      <s:enumeration value="text/html" />
    </s:restriction>
  </s:simpleType>
410

  <!-- Indicates that this item is a returned rows restriction -->
  <s:simpleType name="ReturnedResultCount" type="s:positiveInteger" />

  <!-- Please use the string "Search" as a prefix for all search
415 criteria, and list below -->
  <!-- Indicates that this item is a search string -->
  <s:simpleType name="SearchString" type="s:string" />

420

  </s:schema>
</types>

  <message name="RetrieveSummaryInfoHttpGetIn">
425   <!-- Add other parameters here if they are available, using types defined
  above. -->
   <part name="requestType" type="summaryRequestType" />
   <part name="patientID" type="SearchString" />
   <part name="lowerDateTime" type="s:dateTime" />
430   <part name="upperDateTime" type="s:dateTime" />
   <part name="mostRecentResults" type="ReturnedResultCount" />
  </message>

  <message name="RetrieveSummaryInfoHttpGetOut">
435   <!-- If a complex type is defined for the return value, then it is
  suggested that -->
   <!-- it be used here instead of s0:string. If a complex type is allowed
  as one -->
```

```
440     <!-- of the options, but an arbitrarily formatted string is also allowed,
then create -->
     <!-- a union type here that allows either option. -->
     <part name="Body" element="s0:string" />
</message>

445 <message name="RetrieveListInfoHttpGetIn">
     <!-- Add other parameters here if they are available, using types defined
above. -->
     <part name="requestType" type="listRequestType" />
     <part name="patientID" type="SearchString" />
450 </message>

     <message name="RetrieveListInfoHttpGetOut">
     <!-- If a complex type is defined for the return value, then it is
suggested that -->
455     <!-- it be used here instead of s0:string. If a complex type is allowed
as one -->
     <!-- of the options, but an arbitrarily formatted string is also allowed,
then create -->
     <!-- a union type here that allows either option. -->
460     <part name="Body" element="s0:string" />
</message>
     <message name="RetrieveDocumentHttpGetIn">
     <!-- Add other parameters here if they are available, using types defined
above. -->
465     <!-- It is recommended that one of the sub-types of SearchUID is chosen
here -->
     <!-- Especially if SearchStudyUID is allowed, then the display client can
know that -->
470     <!-- it is permissible to use a dicom uid here -->
     <part name="documentUID" type="SearchString" />
     <part name="contentType" type="contentType" />
</message>

475 <message name="RetrieveDocumentHttpGetOut">
     <!-- If a complex type is defined for the return value, then it is
suggested that -->
     <!-- it be used here instead of s:string. If a complex type is allowed as
one -->
480     <!-- of the options, but an arbitrarily formatted string is also allowed,
then create -->
     <!-- a union type here that allows either option. -->
     <part name="Body" element="s:string" />
</message>

485 <portType name="IHERetrieveForDisplayHttpGet">
     <operation name="RetrieveSummaryInfo">
     <input message="s0:RetrieveSummaryInfoHttpGetIn" />
     <output message="s0:RetrieveSummaryInfoHttpGetOut" />
490 </operation>
     <operation name="RetrieveListInfo">
     <input message="s0:RetrieveListInfoHttpGetIn" />
     <output message="s0:RetrieveListInfoHttpGetOut" />
```

```
495     </operation>
    <operation name="RetrieveDocument">
      <input message="s0:RetrieveDocumentHttpGetIn" />
      <output message="s0:RetrieveDocumentHttpGetOut" />
    </operation>
  </portType>
500
  <binding name="IHERetrieveForDisplayHttpGet"
type="s0:IHERetrieveForDisplayHttpGet">
  <http:binding verb="GET" />
  <operation name="RetrieveSummaryInfo">
505    <http:operation location="/IHERetrieveSummaryInfo" />
    <input>
      <http:urlEncoded />
    </input>
510
    <output>
      <mime:content type="text/html" />
    </output>
  </operation>
515
  <operation name="RetrieveListInfo">
    <http:operation location="/IHERetrieveListInfo" />
    <input>
      <http:urlEncoded />
    </input>
520
    <output>
      <mime:content type="text/html" />
    </output>
  </operation>
525
  <operation name="RetrieveDocument">
    <http:operation location="/IHERetrieveDocument" />
    <input>
      <http:urlEncoded />
530    </input>
    <!-- The type of the output should be restricted on a per-server basis
to the types -->
    <!-- actually provided. -->
535    <output>
      <mime:content type="text/html" />
      <mime:content type="application/x-hl7-cda-level-one+xml" />
      <mime:content type="application/pdf" />
      <mime:content type="image/jpeg" />
540    </output>
  </operation>
</binding>
545
  <!-- Bind the actual service here -->
  <service name="IHERetrieveForDisplay">
    <port name="IHERetrieveForDisplayHttpGet"
binding="s0:IHERetrieveForDisplayHttpGet">
      <http:address location="http://localhost/" />
```

550     </port>  
      </service>

## Appendix B: Definition of Unique Ids

555 Many IHE Profiles rely on the globally unique identification of persistent objects. It is the responsibility of the creating actor (or its delegate) to assign a globally-unique identifier to an object before the object is submitted or, is available for retrieval. This allows other actors to retrieve the same object at different points in time and to obtain the same semantics for its presented content.

560 This appendix describes how unique identifiers shall be created. The requirements specified in this appendix are derived from the common practices and definitions of OIDs in ISO 8824, HL7<sup>®1</sup> V3 and CDA<sup>®2</sup> and UIDs in DICOM<sup>®3</sup>. They guarantee uniqueness across multiple countries, sites, vendors and equipment.

### B.1 Requirements for UIDs

565 The UID identification scheme is based on the OSI Object Identification (numeric form) as defined by the ISO 8824 standard.

All Unique Identifiers used within the context of a Document Sharing transaction shall be extensions of registered values as defined by ISO 9834-3 to ensure global uniqueness. These requirements result in the following structure for unique Ids.

### B.2 Structure of a UID

570 Each UID is composed of two parts, an <org root> and a <suffix> separated by a “period”. Therefore: UID = <org root>.<suffix>

575 The <org root> portion of the UID uniquely identifies an organization, (e.g., manufacturer, research organization, hospital, etc.), and is composed of a number of numeric components as defined by ISO 8824. The <suffix> portion of the UID is also composed of a number of numeric components, and shall be unique within the scope of the <org root>. This implies that the organization identified in the <org root> is responsible for guaranteeing <suffix> uniqueness by providing registration policies. These policies shall guarantee <suffix> uniqueness for all UIDs created by that organization. Unlike the <org root>, which may be common for UIDs in an organization, the <suffix> shall take different unique values between different UIDs that identify 580 different objects. The <org root> is used only for uniqueness and not for any other purpose.

Although a specific implementation may choose some particular structure for its generated UIDs, it should never assume that a UID carries any semantics. A UID shall not be "parsed" to find a particular value or component. Component definition (for the suffix) is implementation-specific

---

<sup>1</sup> HL7 is the registered trademark of Health Level Seven International and the use does not constitute endorsement by HL7.

<sup>2</sup> CDA is the registered trademark of Health Level Seven International and the use does not constitute endorsement by HL7.

<sup>3</sup> DICOM is the registered trademark of the National Electrical Manufacturers Association for its standards publications relating to digital communications of medical information.



xxxxx Identifies a specific Organization (provided by ANSI)

620 In this example the remaining components of the suffix relate to the identification of a specific instance:

4076078054086 802.3 MAC Address (004 076 078 054 086)

11059664469 Time system was booted (July 31, 2033 10:14:29)

235212 Monotonically increasing sequence number

625 In this example, the organization has chosen these components to guarantee uniqueness. Other organizations may choose an entirely different series of components to uniquely identify its objects.

Because of the flexibility allowed in creating UUIDs, implementations should not depend on any assumed structure of UUIDs and should not attempt to parse UUIDs to extract the semantics of some of its components.

## 630 **B.6 Representing UUIDs as OIDs**

635 The standards ITU X.667 and ISO 9834-8 define a particular OID root for the UUIDs, and define the translation between these two formats. The top node 2.25 is assigned for all UUIDs. This means that the UUID that can be written as urn:uuid:f81d4fae-7dec-11d0-a765-00a0c91e6bf6 (using hexadecimal notation) is also 2.25.329800735698586629295641978511506172918 (using dotted decimal notation). It can also be encoded using the ASN.1 rules in a binary form internally within X.509 Certificates and some LDAP messages. All of these are the same OID. The reverse is not true. Not all OIDs can be represented as UUIDs. UUIDs are a subset of the OIDs.

640 This relationship is one way to obtain OIDs in situations where an OID is needed. It is not necessary to use the 2.25 root. An OID assigning authority might take advantage of the UUID generation mechanisms to assign new OIDs within its own root domain. These OIDs would not be UUIDs, but they would be valid OIDs.



## 645 Appendix C: HL7 Profiling Conventions

The HL7 tables included in this document have been modified from the HL7 2.5 standard document. Such a modification is called a profile. Refer to the HL7 2.5 standard for the meanings of specific columns in the table.

650 The profiling tables in this document leverage the ongoing HL7 profile definition. To maintain this specification at a generic level, the following differences have been introduced:

- Message specifications do not indicate the cardinality of segments within a message.
- For fields composed of multiple components, there is no indication of the size of each component.
- 655 • Where a table containing enumerated values is referenced from within a segment profile table, the enumerated values table is not always present.
- The number of times a repeating field can repeat is not indicated.
- The conditions that would require inclusion of conditional fields are not defined when they depend on functional characteristics of the system implementing the transaction and they do not affect data consistency.

660 The following terms refer to the OPT column, which has been profiled:

**R** Required

**R2** This is an IHE extension. If the sending application has data for the field, it is required to populate the field. If the value is not known, the field may not be sent.

665 **R+** This is an IHE extension. This is a field that IHE requires that was listed as optional within the HL7 standard.

**O** Optional

**C** Conditional

670 IHE requires that Z-segments be present in HL7 transactions only when explicitly provided for within the associated IHE message profile specification. According to the HL7 standard, if the value of a field is not present, the receiver shall not change corresponding data in its database. However, if sender includes explicit NULL value (i.e., two double-quotes ""), it shall cause removal of any values for that field in the receiver's database.

Table C-1 provides a sample profile for an imaginary HL7 segment. Tables for real segments are copied from the HL7 2.5 standard with modifications made only to the OPT column.

675 **Table C-1: Sample HL7 Profile**

SEQ	LEN	DT	OPT	TBL#	ITEM #	ELEMENT NAME
1	1	ST	R		xx001	Element 1
2	4	ST	O		xx002	Element 2
3	180	HD	R2		xx003	Element 3
4	180	HD	C		xx004	Element 4

SEQ	LEN	DT	OPT	TBL#	ITEM #	ELEMENT NAME
5	180	HD	O		xx005	Element 5
6	180	HD	R+		xx006	Element 6

## C.1 HL7 Message Profiling Convention

680 The messages used by each transaction are described in this document using static definitions as described for HL7 constrainable message profiles; refer to HL7 Version 2.5, Chapter 2, Section 2.12.6. The static definition of each message is represented within tables. The message level table represents the IHE-constrained message structure with its list of usable segments. The segment level table represents the IHE-constrained content of one segment with its usable fields.

### C.1.1 Static definition - Message level

The message table representing the static definition contains 5 columns:

- 685 • **Segment:** gives the segment name, and places the segment within the hierarchy of the message structure designed by HL7, but hiding the traditional square brackets and braces that designate optionality and repeatability in HL7 standard message tables. The beginning and end lines of a segment group (see HL7 Version 2.5, Chapter 2, Section 2.5.2 for definition) are designated in this column by --- (3 dashes).
- 690 • **Meaning:** Meaning of the segment as defined by HL7. The beginning of a segment group is designated by one line in this column giving the segment group name in all caps, prefixed by --- (3 dashes), and followed by the keyword “begin”. The end of a segment group is designated by one line in this column giving the segment group name in all caps, prefixed by --- (3 dashes), and followed by the keyword “end”.
- 695 • **Usage:** Coded usage of the segment, in the context of this IHE Integration Profile. The coded values used in this column are:
  - 700 **R** Required: A compliant sending application shall populate all "R" elements with a non-empty value. A compliant receiving application may ignore the information conveyed by required elements. A compliant receiving application shall not raise an error due to the presence of a required element, but may raise an error due to the absence of a required element.
  - 705 **RE** Required but may be empty. The element may be missing from the message, but shall be sent by the sending application if there is relevant data. A conformant sending application shall be capable of providing all "RE" elements. If the conformant sending application knows a value for the element, then it shall send that value. If the conformant sending application does not know a value, then that element may be omitted.  
Receiving applications may ignore data contained in the element, but shall be able to successfully process the message if the element is omitted (no error message should be generated if the element is missing).
  - 710

- O** Optional. The usage for this field within the message is not defined. The sending application may choose to populate the field; the receiving application may choose to ignore the field.
- 715 **C** Conditional. This usage has an associated condition predicate. (See HL7 Version 2.5, Chapter 2, Section 2.12.6.6, "Condition Predicate".)  
 If the predicate is satisfied: A compliant sending application shall populate the element. A compliant receiving application may ignore data in the element. It may raise an error if the element is not present.  
 If the predicate is NOT satisfied: A compliant sending application shall NOT populate the element. A compliant receiving application shall NOT raise an error if the condition predicate is false and the element is not present, though it may raise an error if the element IS present.
- 720
- CE** Conditional but may be empty. This usage has an associated condition predicate. (See HL7 Version 2.5, Chapter 2, Section 2.12.6.6, "Condition Predicate".)  
 If the predicate is satisfied: If the conforming sending application knows the required values for the element, then the application must populate the element. If the conforming sending application does not know the values required for this element, then the element shall be omitted. The conforming sending application must be capable of populating the element (when the predicate is true) for all 'CE' elements. If the element is present, the conformant receiving application may ignore the values of that element. If the element is not present, the conformant receiving application shall not raise an error due to the presence or absence of the element.
- 725
- 730 If the predicate is NOT satisfied: The conformant sending application shall not populate the element. The conformant receiving application may raise an application error if the element is present.
- 735
- X** Not supported. For conformant sending applications, the element will not be sent. Conformant receiving applications may ignore the element if it is sent, or may raise an application error.
- 740
- **Cardinality:** Within square brackets, minimum and maximum number of occurrences authorized for this segment in the context of this Integration Profile.
  - **HL7 chapter:** Reference of the HL7 v2.5 chapter that describes this segment.

### C.1.2 Static definition – Segment level and Data Type level

The Segment Table and the Data Type Table each contain 8 columns:

- 745
- **SEQ:** Position (sequence) of the field within the segment.
  - **LEN:** Maximum length of the field
  - **DT:** Field Data Type
  - **Usage:** Usage of the field within this IHE Integration Profile. Same coded values as in the message level: R, RE, C, CE, O, X.

- 750
- **Cardinality:** Minimum and maximum number of occurrences for the field in the context of this Integration Profile.
  - **TBL#:** Table reference (for fields using a set of defined values)
  - **ITEM#:** HL7 unique reference for this field
- 755
- **Element Name:** Name of the field in a Segment table. / Component Name: Name of a subfield in a Data Type table.

**Table C.1.2-1: Example: The MSH segment description**

SEQ	LEN	DT	Usage	Card.	TBL#	ITEM#	Element name
1	1	ST	R	[1..1]		00001	Field Separator
2	4	ST	R	[1..1]		00002	Encoding characters
3	227	HD	R	[1..1]	0361	00003	Sending Application
...							

## C.2 HL7 Implementation Notes

### C.2.1 Network Guidelines

760 The HL7 2.5 standard does not define a network communications protocol. Beginning with HL7 v2.2, the definitions of lower layer protocols were moved to the Implementation Guide, but are not HL7 requirements. The IHE Framework makes these recommendations:

1. Applications shall use the Minimal Lower Layer Protocol defined in Appendix C of the HL7 Implementation Guide.
  2. An initiating application that wants to send a message (initiate a transaction) will initiate a network connection to start the transaction. The receiver application will respond with an acknowledgement or response to query over the open connection. The initiating application can initiate a new transaction on the same connection. However, the initiating application must be able to handle cases where the connection has been closed due to possible timeout by the accepting application. For example if the initiating application does not submit a request over the connection in a timely manner, the accepting application has the right to close the connection. When this condition is detected, the initiating application needs to open a new connection for subsequent requests.
- 765
- 770

### C.2.2 Message Control

775 According to the HL7 standard, each message shall begin with the MSH (message header) segment. Table C.2.2-1 identifies all required fields in this message. This table shall be interpreted according to the HL7 Standard unless otherwise noted in Appendix C.

**Table C.2.2-1: IHE Profile - MSH segment**

SEQ	LEN	DT	OPT	TBL#	ITEM #	Element Name
1	1	ST	R		00001	Field Separator
2	4	ST	R		00002	Encoding Characters
3	180	HD	R+		00003	Sending Application
4	180	HD	R+		00004	Sending Facility
5	180	HD	R+		00005	Receiving Application
6	180	HD	R+		00006	Receiving Facility
7	26	TS	R		00007	Date/Time Of Message
8	40	ST	O		00008	Security
9	13	CM	R	0076/ 0003	00009	Message Type
10	20	ST	R		00010	Message Control ID
11	3	PT	R		00011	Processing ID
12	60	VID	R	0104	00012	Version ID
13	15	NM	O		00013	Sequence Number
14	180	ST	O		00014	Continuation Pointer
15	2	ID	O	0155	00015	Accept Acknowledgment Type
16	2	ID	O	0155	00016	Application Acknowledgment Type
17	3	ID	O	0399	00017	Country Code
18	16	ID	C	0211	00692	Character Set
19	250	CE	O		00693	Principal Language Of Message
20	20	ID	O	0356	01317	Alternate Character Set Handling Scheme
21	427	EI	O		01598	Message Profile Identifier #

780

*Adapted from the HL7 Standard, version 2.5 and version 2.3.1*

Note: This element is only applicable in HL7 version 2.5 and later, and thus is only applicable for those transactions based on HL7 v2.5 and later.

785

The IHE IT Infrastructure Technical Framework requires that applications support HL7-recommended values for the fields *MSH-1-Field Separator* and *MSH-2-Encoding Characters*.

Field *MSH-18-Character Set* shall only be valued if the message utilizes character sets other than ISO IR-6, also known as ASCII.

Implementations supporting sequence number protocol (and using the field *MSH-13-Sequence Number*) shall be configurable to allow them to perform transactions without such protocol.

790

In messages conforming to an IHE Transaction using HL7 v2.5 and later, it is recommended that field *MSH-21-Message Profile Identifier* contain one field repetition with a value representing the IHE transaction identifier, in the form “<domain>-<transaction number>^IHE” (e.g., “ITI-10^IHE”). Other field repetitions may be present with global (HL7-registered), vendor specific, and/or realm specific message profile IDs.

795 **C.2.3 Acknowledgment Modes**

IHE supports both Acknowledgement Modes specified in HL7 standard v2.5 (see HL7 Standard, Section 2.9 “Message Processing Rules”): Original Acknowledgement Mode and Enhanced Acknowledgement Mode.

800 An IHE transaction which uses HL7 messages will explicitly include the requirement for enhanced mode if used. If no such statement is specified, the transaction shall use only original mode.

This section specifies the common structure of the Application Level Acknowledgement Message in the Original Mode (called Application ACK Message for short), and the Commit Acknowledgement Message in the Enhanced Mode (called Commit ACK Message for short).

805 The Application Level Acknowledgement Message in the Enhanced Mode contains the application-specific content, and shall be explicitly specified in the corresponding transaction which requires it. A transaction can, however, refer to the Application ACK Message specified in this section as its Application Level Acknowledgement Message in the enhanced mode if it is suitable.

810 **Table C.2.3-1: Common ACK static definition:**

Segment	Meaning	Usage	Card.	HL7 chapter
MSH	Message Header	R	[1..1]	2
MSA	Message Acknowledgement	R	[1..1]	2
ERR	Error	C	[0..*]	2

In the original mode, the ACK message conveys application errors (if any) detailed by the receiving application.

815 The receiving application shall reject an incoming message, if it does not recognize either the message type (MSH-9.1) or the trigger event (MSH-9.2).

In the Application ACK message, this is an application-rejection, and field MSA-1 of the acknowledgement shall contain the value AR.

In the Commit ACK message, this is a commit-rejection, and Field MSA-1 of the acknowledgement shall contain the value CR.

820 The components of Field ERR-2 of the acknowledgement shall be populated as follows.

- ERR-2.1: **MSH**
- ERR-2.2: **1**
- ERR-2.3: **9**
- ERR-2.4: **1**
- 825 ERR-2.5: **1** if an unrecognized message type
- 2** if an unrecognized trigger event

The components of Field ERR-3 of the acknowledgement shall be populated as follows.

- ERR-3.1:     **200**    if an unrecognized message type
- 201**    if an unrecognized trigger event
- 830       ERR-3.2:   **Unsupported message type** or
- Unsupported trigger event** as appropriate
- ERR-3.3:     **HL70357**

Details of field encoding of these segments are discussed in the following sections.

**C.2.3.1       MSA - Message Acknowledgement segment**

835       Standard Reference: HL7 Version 2.5, Chapter 2 (Section 2.15, “Message control”)

This segment contains information sent while acknowledging another message.

**Table C.2.3.1-1: MSA - Message Acknowledgement**

SEQ	LEN	DT	Usage	Card.	TBL#	ITEM#	Element name
1	2	ID	R	[1..1]	0008	00018	Acknowledgement code
2	20	ST	R	[1..1]		00010	Message Control Id
3	80	ST	X	[0..0]		00020	Text Message
4	15	NM	O	[0..1]		00021	Expected Sequence Number
5			X	[0..0]		00022	Delayed Acknowledgment Type
6	250	CE	X	[0..0]	0357	00023	Error Condition

**MSA-1 Acknowledgment Code (ID)**, required.

840       As is the case throughout IHE, original mode acknowledgement is in use. IHE ITI authorizes two value sets of the acknowledgement codes, both taken from HL7 Table 0008 - Acknowledgement code for the Application and Commit ACK messages, respectively.

In the original mode, the Application ACK message shall use one of the following three codes to populate Field MSA-1:

845       **Table C.2.3.1-2: HL7 Table 0008 - Acknowledgement codes in Application ACK message**

Value	Description	Comment
AA	Original mode: Application Accept	The message has been accepted and integrated by the receiving application
AE	Original mode: Application Error	The message contains errors. It SHALL not be sent again without correcting the error.
AR	Original mode: Application Reject	The message has been rejected by the receiving application. If the rejection is not related to an invalid value in the MSH segment, the sender may try again to send the message later.

In the enhanced mode, the Commit ACK message shall use one of the following three codes to populate Field MSA-1:

**Table C.2.3.1-3: HL7 Table 0008 - Acknowledgement codes in Commit ACK message**

Value	Description	Comment
CA	Enhanced mode: Commit Accept	The message has been received and safe-kept in the receiving application for processing. No resend is required.
CE	Enhanced mode: Commit Error	The message contains errors. It SHALL not be sent again without correcting the error.
CR	Enhanced mode: Commit Reject	The message has been rejected by the receiving application. If the rejection is not related to an invalid value in the MSH segment, the sender may try again to send the message later.

850 **MSA-2 Message Control ID (ST)**, required.

Definition: This field contains the message control ID from Field MSH-10-Message Control ID of the incoming message for which the acknowledgement is sent.

**MSA-3 Text Message (ST)**, not supported. See the ERR segment.

**MSA-6 Error Condition (CE)**, not supported. See the ERR segment.

855 **C.2.3.2 ERR - Error segment**

Standard Reference: HL7 Version 2.5, Chapter 2 (Section 2.15, “Message control”)

This segment is used to add error comments to acknowledgment messages.

**Table C.2.3.2-1: ERR – Error segment**

SEQ	LEN	DT	Usage	Card.	TBL#	ITEM#	Element name
1	493	ELD	X	[0..0]		00024	Error Code and Location
2	18	ERL	RE	[0..*]		01812	Error Location
3	705	CWE	R	[1..1]	0357	01813	HL7 Error Code
4	2	ID	R	[1..1]	0516	01814	Severity
5	705	CWE	O	[0..1]	0533	01815	Application Error Code
6	80	ST	O	[0..10]		01816	Application Error Parameter
7	2048	TX	O	[0..1]		01817	Diagnostic Information
8	250	TX	O	[0..1]		01818	User Message
9	20	IS	O	[0..*]	0517	01819	Inform Person Indicator
10	705	CWE	O	[0..1]	0518	01820	Override Type
11	705	CWE	O	[0..*]	0519	01821	Override Reason Code
12	652	XTN	O	[0..*]		01822	Help Desk Contact Point

860 **ERR-1** is deprecated in HL7 Version 2.5 (i.e., retained for backward compatibility only) and therefore not supported by IHE.

**ERR-2** is populated except when the error is not within an HL7 field, component or subcomponent. For example, if the receiver returns an acknowledgement containing *MSA-2-*



865 *acknowledgement code* value **AR** or **CR** to indicate that the receiving application was unavailable, ERR-2 is not populated.

**ERR-3 HL7 Error Code (CWE)** is required. It identifies the HL7 (communication) error code. Valid values are given by HL7 Table 0357:

**HL7 Table 0357: Message error condition codes**

Value	Description	Comment
0	Message accepted	Success. Optional, as the AA conveys success. Used for systems that must always return a status code.
100	Segment sequence error	Error: The message segments were not in the proper order, or required segments are missing.
101	Required field missing	Error: A required field is missing from a segment
102	Data type error	Error: The field contained data of the wrong data type, e.g., an NM field contained "FOO".
103	Table value not found	Error: A field of data type ID or IS was compared against the corresponding table, and no match was found.
200	Unsupported message type	Rejection: The Message Type is not supported.
201	Unsupported event code	Rejection: The Event Code is not supported.
202	Unsupported processing id	Rejection: The Processing ID is not supported.
203	Unsupported version id	Rejection: The Version ID is not supported.
204	Unknown key identifier	Rejection: The ID of the patient, order, etc., was not found. Used for transactions other than additions, e.g., transfer of a non-existent patient.
205	Duplicate key identifier	Rejection: The ID of the patient, order, etc., already exists. Used in response to addition transactions (Admit, New Order, etc.).
206	Application record locked	Rejection: The transaction could not be performed at the application storage level, e.g., database locked.
207	Application internal error	Rejection: A catchall for internal errors not explicitly covered by other codes.

870 **ERR-4 Severity (ID)** is required. It identifies the severity of an application error. Valid values are given by HL7 Table 0516:

**HL7 Table 0516: Error severity**

Value	Description	Comment
W	Warning	Transaction successful, but there may be issues
I	Information	Transaction was successful but includes information, e.g., inform patient
E	Error	Transaction was unsuccessful

### C.2.4 Common Segment Definitions

875 The following table specifies the contents of the EVN segment that is common to several HL7-based messages defined in ITI TF-2a and 2b.

**Table C.2.4-1: IHE Profile - EVN segment**

SEQ	LEN	DT	OPT	TBL#	ITEM#	ELEMENT NAME
1	3	ID	O	0003	00099	Event Type Code
2	26	TS	R		00100	Recorded Date/Time
3	26	TS	O		00101	Date/Time Planned Event
4	3	IS	O	0062	00102	Event Reason Code
5	60	XCN	O	0188	00103	Operator ID
6	26	TS	R2		01278	Event Occurred
7	180	HD	O (Note 1)		01534	Event Facility #

*Adapted from the HL7 Standard, version 2.5 and version 2.3.1*

Note 1: This element is only applicable in HL7 version 2.5 and thus is only applicable for those transactions based on HL7 v2.5

880 Field *EVN-1-Event Type Code* is optional; however, if present, its value shall be equal to the second component of the field *MSH-9-Message Type*.

### C.2.5 Message granularity

885 The sending application shall send as many messages as there are events recorded. For instance, if at the same time there is a change both to the patient's location (from emergency room to GI surgery ward) and to the patient's attending doctor (from Dr. Eric Emergency to Dr. John Appendectomy), the sending application will transmit two movements using HL7 messages ADT^A02 (transfer) and ADT^A54 (change attending doctor). Both events will have the same effective date/time (EVN-6 – Event Occurred). If the Historic Movement Option is in use, each of these movements will have a unique identifier.

890 The exceptions to this fine granularity are:

- The Admit Inpatient (A01) and Register Outpatient (A04) events can also assign a location and an attending doctor to the patient, known when the event is recorded.
- A change of patient class (A06 or A07) also assigns at the same time a new location to the patient.
- 895 • The Cancel Discharge/End Visit event also includes at the same time the patient location after the cancellation has been processed.

### C.2.6 HL7 empty field convention

900 According to the HL7 standard, if the value of a field is not present, the receiver shall not change corresponding data in its database. However, if the sender defines the field value to be the explicit NULL value (i.e., two double quotes ""), it shall cause removal of any values for that field in the receiver's database. This convention is fully applied by IHE profiles based on HL7 v2.x messages.

## Appendix D: Cross-Profile Interactions of PIX and PSA

905 When the Context Manager in a Patient Synchronized Application Integration Profile is grouped with a Patient Identifier Cross-reference Consumer in a Patient Identifier Cross-referencing Integration Profile, patient identifiers must be accessible to both actors in a consistent manner. This Appendix provides the necessary mapping rules.

910 The Patient Identifier Cross-Referencing (PIX) Integration Profile defines a general-purpose mapping of a Patient ID within a Patient Identification Domain to aliases in other Patient Identification Domains. This mapping is intended to be used across all IHE systems that require patient identification in transactions crossing Patient Identification Domains. The PIX Integration Profile relies on HL7 V2 transactions.

915 The Patient Synchronized Application Integration Profile relies on HL7 CCOW which, confronted with a similar need, has defined a Patient Mapping API within its architecture. The HTTP Technology mapping for the CCOW Patient Mapping Agent API supports its operation over a network interface, thus creating an alternative to HL7 V2 messages.

920 As IHE strives to avoid the inclusion in its integration profiles of incompatible but functionally equivalent variants, it has decided to use HL7 V2 ADT messages for the Patient Identifier Cross-referencing Integration Profiles. In consequence, the combined use of the Patient Synchronized (CCOW based) Integration Profile and of the Patient Identifier Cross-referencing Integration profiles requires that the IHE Context Manager use the services of the PIX Integration Profile. To do so, the Patient Identifier Cross-reference Consumer in communication with the Patient Identifier Cross-reference Manager operates as a substitute for the CCOW Patient Mapping Agent. This is shown in Figure D-1 below as a dashed oval surrounding the Patient Cross-reference Manager and the Patient Identifier Cross-reference Consumer Actors. As a result it is likely that a context management solution would bundle a PMA proxy application that would implement the PIX Query in support of the Patient Identifier Cross-reference Consumer.

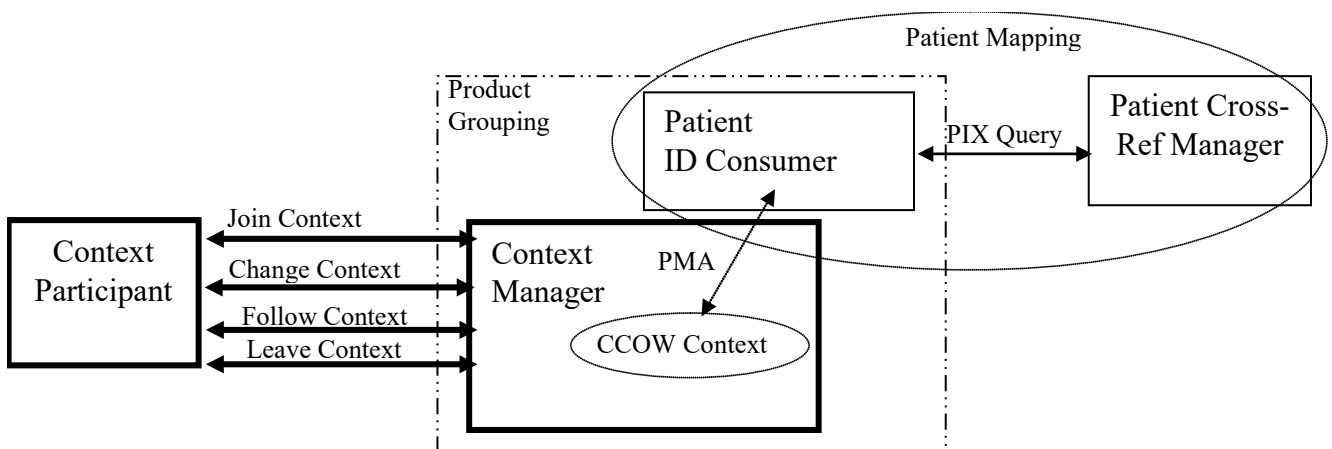

930 **Figure D-1: Actor Grouping Diagram**

This Appendix provides the definition of the mapping of the CCOW Patient Mapping Agent API methods onto the PIX Query Transaction (HL7 V2 QBP^Q23/RSP^K23) as defined by the PIX Integration Profile.

935 Figure D-1 shows the definition of the Patient Mapping Methods parameters as implemented in Web technology. Most of these Arguments relate to the normal operations of the Patient Mapping Agent methods that pose no mapping challenge except for the ItemNames and ItemValues which pose some constraints. The first constraint comes from the translation of Patient Identity Domains for both query and response from and to a CCOW defined name / value pair. The second one comes from the fact that CCOW participant applications can set more than one identifier in context the ability to detect when these identifiers represent the identities of more than one patient. IHE has taken steps to mitigate these issues by further restricting how the IHE Context Participant implements the methods. Each of these constraints is addressed in sections below.

945 **Table D-1: ContextChangesPending**

HTTP Request Message		
Argument Name	Data Type	Comment
Interface	string	“ContextAgent”
Method	string	“ContextChangesPending”
agentCoupon	long	“-1”
contextManager	string	URL for the Context Manager that is requesting the patient id cross-reference
itemNames	string[]	One or more item names (e.g., Patient.Id.IdList)
itemValues	string[]	The patient identifiers corresponding to the domains identified in item names
contextCoupon	long	Context Coupon value for pending context change transaction
managerSignature	string	Not required
HTTP Reply Message		
agentCoupon	long	“-1”
itemNames	string[]	See below for valid item names for patient subject
itemValues	string[]	See below for any constraints on item values
contextCoupon	long	Return the value provided in request
agentSignature	string	Not required
Decision	string	“valid” or “invalid”
Reason	string	Reason text if mapping is invalid

*Adapted from the HL7 Context Management “CCOW” Standard, version 1.4*

## D.1 Namespace Translation from PIX Query to CCOW

950 The CCOW standard defines multiple identifier items that may be set into the context by an instigating participant application. The current list of valid identifier names are listed in Table D-2.

**Table D-2: Patient Subject Identifiers**

Patient Subject Identifier Item Name	HL7 Meaning	HL7 Data Type	HL7 Semantic Constraints on Values	Case Sensitive
Patient.Id.MRN.Suffix	Patient medical record number, per PID-2	ST	HL7 Table 0203 Identifier Type = MR	No
Patient.Id.MPI	Patient identifier in the “Master Patient Index”, per PID-2	ST	HL7 Table 0203 Identifier Type = PT or PI (as agreed upon by context sharing systems) and Assigning Authority represents the MPI system	No
Patient.Id.NationalIdNumber	Patient national identifier number, per PID-2	ST	HL7 Table 0203 Identifier Type = PT and Assigning Authority represents agreed upon National Authority	No
Patient.Id.IdList	A list of patient identifiers for a patient, per PID-3	CX	May be a repeating set of CX item values (per Section 1.7 of the HL7 Context Management “CCOW” Standard: Subject Data Definitions document), each of which contains an identifier that denotes the same patient	No

*Adapted from the HL7 Context Management “CCOW” Standard, version 1.4*

955 IHE has specified in the Context Change Transaction as documented in ITI TF-2a that the Context Participant shall use the Patient.Id.IdList item. The intent is to eliminate translation as the Patient.Id.IdList value maps directly to PIX Query Transaction QPD-3.

Applications using in their identifier items Patient.Id.MRN.Suffix will need to migrate to the Patient.Id.IdList item as expected by the HL7 CCOW standard.

960 **D.2 Processing Multiple Identifiers**

CCOW participant applications are permitted to populate as many patient identifiers as they have available to them. This means that when a user selects a patient in one of these applications the context is populated with multiple identifiers for the selected patient. When the CCOW Patient Mapping Agent (PMA) accepts multiple patient identifiers as input, the PMA has the responsibility of invalidating patient mapping and causing the context change transaction to be cancelled if it determines that the multiple identifiers supplied as part of the transaction identify more than one patient.

970 The QPD segment as defined in the IHE PIX Query Transaction specifies a single identifier uniquely identifying one patient within a given Patient Identification Domain. In the case where multiple identifiers are populated, the context manager may have to process the response to the initial PIX Query Transaction to evaluate if the other identifiers in context are included. If so, no further processing is required. Otherwise, an additional PIX Query will need to be issued and the results processed. Should a non-null result be returned, indicating the identifier uniquely identifies a different patient for the given domain, the context manager shall assume “invalid” in the decision field and “multiple patients identified” in the reason field.

980 In order to mitigate this condition, IHE specifies that all context participants supporting the Patient Synchronized Applications Profile shall only set one identifier for the patient when a Patient Identifier Cross-referencing Profile is used by the context manager. This means that the context participant for those applications that manage multiple patient identifiers will need to be configurable as to which identifier item is passed in the Change Context Transaction.

## Appendix E: Patient Identifiers in HL7-based IHE Profiles

The Health Level Seven Standard (HL7) uses data type CX to express various identifiers, including the Patient ID in the third field of the PID segment. We discuss here how IHE IT Infrastructure expects the CX data type to be populated in the *PID-3-Patient Identifier List* fields of messages that it defines.

Requirements for populating the elements of *PID-3-Patient Identifier List* vary slightly, depending on what actor is originating the transaction in which the PID segment is sent. If the Patient Identifier Cross-reference Manager is the source of the PID segment, the requirements (specifically, with respect to populating the Assigning Authority subcomponents) are more rigorous than otherwise.

*PID-3-Patient Identifier List* permits multiple occurrences of the CX data type. Data type CX contains 8 components as shown below. This structure allows expression of the value and context for each identifier that the system knows.

995 **Table E-1: Components of HL7 Data Type CX**

Cmp	Len	DT	Opt	Tbl	Name
1	15	ST	R		ID
2		ST	O		Check digit
3		ID	O	0061	Code identifying the check digit scheme employed
4	227	HD	R		Assigning authority
5		ID	O	0203	Identifier type code
6		HD	O		Assigning facility
7		DT	O		Effective date
8		DT	O		Expiration date

*Adapted from the HL7 Standard, Version 2.5*

Each occurrence of *PID-3-Patient Identifier List* contains, at a minimum, an identifier value in Component 1 and an assigning authority in Component 4. The assigning authority unambiguously provides the context for the identifier. It is also common practice to provide an identifier type code in Component 5, but this is not required by IHE in the context of the PIX transactions [ITI-8], [ITI-9], and [ITI-10]. Other components are optional and will not be discussed here; implementers may refer to HL7 Version 2.5 for more information.

Component 1 of Data Type CX, **ID**, is of data type ST. This data type allows a free text value of up to 15 characters.<sup>4</sup>

1005 Component 4 of Data Type CX, **Assigning Authority**, is of data type HD. This data type contains 3 components that, when implemented at the component level, become subcomponents of Component 4. The requirements for the subcomponents of Component 4 vary by actor.

<sup>4</sup> As implemented in HL7 Version 2.5. Prior to Version 2.5, HL7 did not specify the length of individual components. Although the profiles in IHE-ITI are based Versions 2.3.1 and 2.4 of HL7, they use the component length constraints provided by Version 2.5 to support forward compatibility.

## E.1 Patient Identifier Cross-reference Manager Actor Requirements

1010 The Patient Identifier Cross-reference Manager is expected to have access to complete internal and external identifier information for the Assigning Authority of the patient identifier. To facilitate interoperability, it is required that the Patient Identifier Cross-reference Manager populate all subcomponents of the Assigning Authority component. The usage of these subcomponents will be explained in the examples below.

1015 This requirement applies to the response portion of the PIX Query [ITI-9] and PIX Update Notification [ITI-10] transactions.

**Table E-2: Usage of HL7 Data Type CX by the PIX Manager Actor**

Cmp	Sbc	Len	DT	Opt	Tbl	Name	Conditionality predicate
1		15	ST	R		ID	
2			ST	O		Check digit	
3			ID	O	0061	Code identifying the check digit scheme employed	
4		227	HD	R		Assigning authority	Subcomponent 1 must refer to the same entity as Subcomponents 2 and 3.
4	1	20	IS	R	0363	Namespace ID	
4	2	199	ST	R		Universal ID	
4	3	6	ID	R	0301	Universal ID type	
5			ID	O	0203	Identifier type code	
6			HD	O		Assigning facility	If all three subcomponents are populated, they must refer to the same entity.
6	1		IS	O	0300	Namespace ID	
6	2		ST	C		Universal ID	Populated if, and only if, Subcomponent 3 is populated.
6	3		ID	C	0301	Universal ID type	Populated if, and only if, Subcomponent 2 is populated
7			DT	O		Effective date	
8			DT	O		Expiration date	

IHE specifies that the Patient Identifier Cross-reference Manager must populate all 3 subcomponents of Component 4. The following rules apply:

1020 Subcomponent 1 of Component 4, **Namespace ID**, is of data type IS. HL7 specifies that when valued in the Patient ID field, the value in this subcomponent be a code taken from user-defined Table 0363, *Assigning Authority*. Version 2.5 of HL7 provides suggested values for assigning authorities in various local jurisdictions, such as **USSSA** for U.S. Social Security Administration. Sites may add values to this table, but for interoperability must ensure that added values (and

1025 meanings) are agreed upon by all communicating systems.



Subcomponent 2 of Component 4, **Universal ID**, is of data type ST. This subcomponent contains a value from either a known external domain or a specified internal domain. The domain is given in Subcomponent 3.

1030 Subcomponent 3, **Universal ID Type**, is of data type ID. This subcomponent contains a code taken from HL7 Table 0301, *Universal ID Type*. Table 0301 contains values for various known external identifier domains such as **DNS** (Internet dotted name) and **ISO** (International Standards Organization Object Identifier, or OID), as well as the values **L**, **M**, and **N** to permit the use of internal identifier domains.

Subcomponent 1 must refer to the same entity as Subcomponents 2 and 3.

1035 **E.1.1 Other actor requirements**

The PID segment may also appear in messages generated by other IHE actors, including the Patient ID Cross-reference Consumer and the Information Source. These actors must also populate the Assigning Authority.

1040 However, IHE specifies that they need not populate all three subcomponents of Assigning Authority. They must populate either Namespace ID (an entry from a user-defined table), or Universal ID and Universal ID Type (allowing the use of an externally defined identifier scheme).

1045 This requirement applies to the Patient Identity Feed [ITI-8] transaction and to the query portion of PIX Query [ITI-9]. This requirement does not apply to the response portion of [ITI-9] nor to PIX Update Notification [ITI-10].

**Table E-3: Usage of HL7 Data Type CX by other IHE Actors**

Cmp	Sbc	Len	DT	Opt	Tbl	Name	Conditionality predicate
1		15	ST	R		ID	
2			ST	O		Check digit	
3			ID	O	0061	Code identifying the check digit scheme employed	
4		227	HD	R		Assigning authority	If all three subcomponents are populated, they must refer to the same entity.
4	1	20	IS	C	0363	Namespace ID	Must be populated if Subcomponents 2 and 3 are not populated.
4	2	199	ST	C		Universal ID	Must be populated if Subcomponent 1 is not populated. Populated if, and only if, Subcomponent 3 is populated.
4	3	6	ID	C	0301	Universal ID type	Must be populated if Subcomponent 1 is not populated. Populated if, and only if, Subcomponent 2 is populated.
5			ID	O	0203	Identifier type code	

Cmp	Sbc	Len	DT	Opt	Tbl	Name	Conditionality predicate
6			HD	O		Assigning facility	If all three subcomponents are populated, they must refer to the same entity.
6	1		IS	O	0300	Namespace ID	
6	2		ST	C		Universal ID	Populated if, and only if, Subcomponent 3 is populated.
6	3		ID	C	0301	Universal ID type	Populated if, and only if, Subcomponent 2 is populated.
7			DT	O		Effective date	
8			DT	O		Expiration date	

1050 The definitions of the subcomponents of Component 4 are as given above for the Patient Identifier Cross-reference Manager. If all three subcomponents are defined, Subcomponent 1 must refer to the same entity as Subcomponents 2 and 3.

### E.1.2 Examples of use

Metropolitan Medical Center treats a patient, Jane Smith, for whom 3 identifiers are known. (For this example, assume that the HL7 V2 default delimiters are in use: | for field separator, ^ for component separator, ~ for repetition separator and & for subcomponent separator.)

### 1055 E.1.3 Data sent by source systems

The source systems provide data to the Patient Identifier Cross-reference Manager. These data are sent either in a Patient Identity Feed [ITI-8] transaction or in response to a PIX Query [ITI-9].

1060 Patient Smith's Social Security number is **999-99-4452**. This number is assigned by the U.S. Social Security Administration.

The ADT system sends the Social Security number at registration, in an occurrence of *PID-3-Patient Identifier List* that looks like this:

**999-99-4452^^^USSSA**

1065 Note that only Subcomponent 1 of Assigning Authority is assigned here, while Subcomponents 2 and 3 are left empty.

Patient Smith's medical record number is **9990-99497**. This number is assigned by Metropolitan Medical Center, for which no external identifier is known. Metropolitan Medical Center incorporates the Namespace ID **99MMC** for the medical record numbers it assigns.

1070 The ADT system sends the medical record number at registration, in an occurrence of *PID-3-Patient Identifier List* that looks like this:

**999099497^^^99MMC**

Note again that only Subcomponent 1 of Assigning Authority is assigned here.

Patient Smith's medical insurance number is **99998410**. This number is assigned by MLH Life & Casualty Company, whose Internet domain name is **www.mlhlifecasualty.com**.<sup>5</sup>

1075 The billing system sends the medical insurance number in an occurrence of *PID-3-Patient Identifier List* that looks like this:

**99998410^^^&www.mlhlife.com&DNS**

Note that only Subcomponents 2 and 3 of Assigning Authority are assigned here. Also note the value **DNS** in the third subcomponent of Component 4 to indicate an Internet domain name.

1080

#### **E.1.4 Data sent by the Patient Identifier Cross-reference Manager**

The Patient Identifier Cross-reference Manager implements HL7 Table 0363, *Assigning Authority*, by incorporating the values in HL7 Version 2.5 as well as the values **99MMC** for Metropolitan Medical Center and **99MLHLIFE** for MLH Life & Casualty.<sup>6</sup> It also includes a known ISO Object Identifier for the Social Security Administration, **1.2.mm.nnnnn.555.6666**.<sup>7</sup>

1085

To send the identifiers in *PID-3-Patient Identifier List*, the Patient Identifier Cross-reference Manager builds and concatenates them as follows.

In the first occurrence, the Social Security number is sent in the first component, as well as the known internal and external values for SSN assigning authority in the fourth component. Note the value **ISO** in the third subcomponent of Component 4 to indicate an ISO Object Identifier.

1090

**999-99-4452^^^USSSA&1.2.mm.nnnnn.555.6666&ISO**

In the second occurrence, the medical insurance number is sent in the first component, as well as the known internal and external values for insurance number assigning authority in the fourth component.

1095

**99998410^^^99MLHLIFE&www.mlhlife.com&DNS**

In the third occurrence, the medical record number is sent in the first component, as well as the known internal and external values for MRN assigning authority in the fourth component. Note that no external value is known for MRN assigning authority, so the HIS repeats the internal value as an external value and uses the value **L** in the third subcomponent of Component 4 to indicate a locally assigned value.

1100

**999099497^^^99MMC&99MMC&L**

---

<sup>5</sup> Implementers should take into account the possibility that, as with any domain identifier, Internet domain identifiers – either fully qualified domain names (FQDNs) or IPv4 or IPv6 addresses – are liable to change.

<sup>6</sup> The use of **99** to preface these codes is not mandated by HL7, but reflects the practice directed by Chapter 7 of HL7 Version 2.5 for specifying local coding system values.

<sup>7</sup> This OID is fictitious. The real OID for the SSA should be substituted here.

1105 In sending all values in a PIX Update Notification [ITI-10] transaction, the Patient Identifier Cross-reference Manager concatenates the three *PID-3-Patient Identifier List* values using the repetition separator:

```
|999994452^^^USSSA&1.2.mm.nnnnn.555.6666&ISO~99998410^^^99A  
BCLIFE&www.abclife.com&DNS~999099497^^^99MMC&99MMC&|
```

## E.2 HL7 V3 II Data Type

1110 The Health Level Seven Standard Version 3 (HL7 V3) uses data type II to express an identifier that uniquely identifies a thing or object (see HL7 Version 3 Standard Data Types), including medical record number or other patient identifiers. We discuss here how IHE IT Infrastructure profiles the use of II data type to express patient identifiers in HL7 V3 messages and HL7 V3 CDA Document Templates defined or referenced in this Technical Framework. In the following  
1115 text of this section, all requirements for the II data type are specified solely in the context of patient identifier expression.

Since IHE adds additional constraints to the II data type, requirements for populating its elements vary slightly, depending on what actor is originating a transaction (or create a CDA document), in which Patient ID is expressed. If the Patient Identifier Cross-reference Manager is  
1120 the source of the Patient ID in a message, the requirements (specifically, with respect to populating the assigningAuthorityName elements) are more rigorous than otherwise.

The IHE IT Infrastructure Technical Framework adds constraints to the II data type for Patient ID expression in HL7 V3 messages or CDA documents, in order to maintain compatibility with the explicit relationship between a Patient ID Domain (assigning authority) and a Patient ID  
1125 issued in the Domain present in the HL7 V2 CX data type. In HL7 V2 messages defined in the IHE IT Infrastructure Technical Framework, Patient ID is expressed in the form of an identifier value (CX.ID) issued in a domain (CX.AssigningAuthority) (see Section E.1). Even though HL7 V3 provides additional mechanisms for an explicit expression of the key concept of Patient ID Domain (via scoping organizations), the constraints added to the II data type in this section  
1130 enable a seamless interoperability among HL7 V2 messages, HL7 V3 messages, as well as CDA documents, which may participate in the same IT Infrastructure Profile.

At the same time, it is also important to represent the RIM-based association between assigning authority and patient identifiers, which is expected by systems using the rich semantics of the RIM. In order to achieve that IHE imposes several constraints regarding patient IDs on the HL7  
1135 V3 models used in IHE transactions:

1. Identifiers for the patient are class attributes of a specific role, and never of the Person class of the patient.
2. When the Patient role is scoped by a Provider organization, only patient IDs assigned by the provider organization are allowed in the Patient class, the root element of the patient IDs shall match the root element of the provider organization ID, and the provider organization ID shall have no extension element.
3. When any other role associated with the Person class of the patient is scoped by an organization, the root element of the role IDs shall match the root element of the scoping organization ID, and the scoping organization ID shall have no extension element.

- 1145 4. A receiver of an HL7 v3 message shall consider the IDs in all roles associated with the Person class of the patient as valid patient IDs.
- 1150 5. A receiver of an HL7 v3 message shall not be required to maintain the various roles associated with the Person class of the patient, as long as, when becoming a sender, it can appropriately send all relevant patient IDs according to the requirements of a particular transaction.

### E.2.1 Patient Identifier Cross-reference Manager requirements

1155 The Patient Identifier Cross-reference Manager is expected to have access to complete information for a Patient ID value and its issuing Patient ID Domain (assigning authority). To facilitate interoperability, it is required that the Patient Identifier Cross-reference Manager provide all this information in an instance of II the data type to express Patient ID. Table E-2.1-1 specifies the requirements of the II data type to the Patient Identifier Cross-reference Manager.

**Table E.2.1-1: Usage of HL7 V3 II Data Type by the PIX Manager**

Name	Type	Opt	Name
Root	OID	R	An ISO OID of the Patient ID Domain (assigning authority) that guarantees the global uniqueness of the patient identifier.
Extension	ST	R+	A character string as a unique identifier within the scope of the Patient ID Domain (assigning authority) represented by the identifier root.
assigningAuthorityName	ST	R+	A human readable name or mnemonic for the assigning authority. The Assigning Authority Name has no computational value. The purpose of an Assigning Authority Name is to assist an unaided human interpreter of an II value to interpret the authority. Note: no automated processing must depend on the assigning authority name to be present in any form.
Displayable	BL	O	Specifies if the identifier is intended for human display and data entry (displayable = true) as opposed to pure machine interoperation (displayable = false).

1160 IHE specifies that the Patient Identifier Cross-reference Manager must populate both elements root and extension for Patient ID Domain and Patient ID value, respectively, and element root must be an ISO OID. If the same patient identifier is populated in a HL7 V2 message, element root and extension shall correspond to CX.4.2 and CX.1, respectively, and CX.4.3 shall be ISO (see Section E.1).

1165 In addition, IHE requires that the Patient Identifier Cross-reference Manager populates element assigningAuthorityName. Though there is no additional requirement for the data type of this element than a text string in a HL7 V3 message or CDA document, it shall be the same value as populated in CX.4.1, if the actor participates in transactions of both HL7 V3 and HL7 V2 messages. In this case, element assigningAuthorityName shall contain a value of HL7 V2 data type IS, a code taken from user-defined Table 0363, Assigning Authority, see Section E.1.

1170 **E.2.2 Other actor requirements**

The patient identifier information may also appear in HL7 V3 messages or CDA documents generated by other IHE actors, including the Patient Identifier Cross-reference Consumer, the Patient Information Source, XDS Document Source. Table E.2.2-1 specifies requirements for these actors when populating a value of the II data type to express a patient identifier.

1175

**Table E.2.2-1: Usage of HL7 Data Type CX by other IHE Actors**

Name	Type	Opt	Name
Root	OID	R	An ISO OID of the Patient ID Domain (assigning authority) that guarantees the global uniqueness of the patient identifier.
Extension	ST	R+	A character string as a unique identifier within the scope of the Patient ID Domain (assigning authority) represented by the identifier root.
assigningAuthorityName	ST	O	A human readable name or mnemonic for the assigning authority. The Assigning Authority Name has no computational value. The purpose of an Assigning Authority Name is to assist an unaided human interpreter of an II value to interpret the authority. Note: no automated processing must depend on the assigning authority name to be present in any form.
Displayable	BL	O	Specifies if the identifier is intended for human display and data entry (displayable = true) as opposed to pure machine interoperation (displayable = false).

1180 These actors are not required to provide a value for element assigningAuthorityName. However, if they choose to provide a value of this element and generate both HL7 V2 messages and HL7 V3 messages or CDA documents, the same requirement for the Patient Identifier Cross-reference Manager applies (see Section E.2.1).

**E.2.3 Examples of use**

1185 The similar case of Metropolitan Medical Center in Section E.1.2 is used to provide HL7 V3 II data type for patient identifier expression in this section. Since element root of the II data type is always required and must be an ISO OID, the example case is adopted (compared to Section E.1.2).

**E.2.3.1 Data sent by source systems**

The source systems provide data to the Patient Identifier Cross-reference Manager. These data are sent in a Patient Identity Feed HL7 V3 [ITI-44] transaction.

- 1190 • Patient Smith’s Social Security number is 999-99-4452. This number is assigned by the U.S. Social Security Administration, which uses a known ISO Object Identifier for issuing the Social Security Numbers, 2.16.840.1.113883.4.1.<sup>8</sup>
- Patient Smith’s medical record number is 9990-99497. This number is assigned by Metropolitan Medical Center. The ISO OID of its medical record number domain is 1.2.xx.yyyyy.123.4567.<sup>9</sup>
- 1195 • Patient Smith’s medical insurance number is 99998410. This number is assigned by MLH Life & Casualty Company, whose ISO OID for issuing insurance numbers is 1.2.xxx.yyyyy.987.6543.<sup>10</sup>

The source system will include the patient identifier information of the II data type in a HL7 V3 message generated for the Patient Identity Feed transaction or Patient Identity Cross-Reference or Patient Demographics Query Request as shown in the following:

1200

```

<identifiedPerson>
  <id root="2.16.840.1.113883.4.1" extension="999-99-4452" />
  <id root="1.2.xx.yyyyyy.123.4567" extension="9990-99497" />
  <id root="1.2.xx.yyyyy.987.6543" extension="99998410" />
  :
  :
</identifiedPerson>
```

1205

### 1210 **E.2.3.2 Data sent by the Patient Identifier Cross-reference Manager**

The Patient Identifier Cross-reference Manager implements HL7 V2 Table 0363, Assigning Authority, which includes the names of identifier domains (assigning authorities) used in the example of Section E.2.3.1:

- US Social Security Administration: USSSA
- 1215 • Medical record number domain of Metropolitan Medical Center: 99MMC
- Insurance number domain of MLH Life & Casualty Company: 99MLHLIFE

To send the patient identifiers, the Patient Identifier Cross-reference Manager builds a HL7 V3 message as follows:

1220

---

<sup>8</sup> As registered in the HL7 OID registry at <http://www.hl7.org/oid/index.cfm>

<sup>9</sup> This OID is fictitious, which is emphasized by the incorrect formatting using letters

<sup>10</sup> This OID is fictitious, which is emphasized by the incorrect formatting using letters

```
1225 <identifiedPerson>
      <id root="2.16.840.1.113883.4.1" extension="999-99-4452"
        assigningAuthorityName="USSSA"/>
      <id root="1.2.xx.yyyyyy.123.4567" extension="9990-99497"
        assigningAuthorityName="99MMC"/>
      <id root="1.2.xx.yyyyy.987.6543" extension="99998410"
        assigningAuthorityName="99MLHLIFE"/>
      :
      :
1230 </identifiedPerson>
```



## Appendix F: Character String Comparisons

1235 All metadata character string comparisons shall be done in conformance with the rules of the Unicode standard (<http://www.unicode.org/versions/latest/>) using the normalized form C defined in Unicode Technical Report 15 (<http://unicode.org/reports/tr15>).

All XML ID comparisons and OID comparisons shall be compared in a case sensitive way.

1240 Note: Latin alphabet case-sensitive NFC matching corresponds to byte string matching. The primary impact of this is for non-Latin alphabets. They need to be converted into normalized form before comparison. The TR 15 approach is consistent with the working documents of W3C, although W3C has not yet issued a balloted recommendation that Unicode normalized form C be used. See <http://www.w3.org/TR/WD-charreq>, <http://www.w3.org/International/charlint/>, and the current W3C draft (<http://www.w3.org/TR/charmod-norm>).

- 1245 **Appendix G: Intentionally Left Blank**
- Appendix H: Intentionally Left Blank**
- Appendix I: Intentionally Left Blank**
- Appendix J: Intentionally Left Blank**

1250

## Appendix K: XDS Security Environment

This Appendix expands on the summary provided in the XDS Profile (ITI TF-1: 10.8).

1255 The XDS operations assume that a suitable security and privacy environment has been established. Almost all of the relevant threats will be managed by agreements, policies, and technologies that are external to the XDS transactions. The few that affect the XDS transactions will be managed by generic security mechanisms that are not unique to XDS. The threats and security objectives that must be addressed are described in Sections K.1 and K.2 below. Only a few of these have issues that are unique to the XDS application.

1260 Section K.3 discusses these few threats and objectives in terms of the agreements and policies that need to be established to create a suitable environment for XDS. Establishing these agreements often involves business agreement discussions that are part of establishing the XDS Affinity Domain. These agreements are necessary because the exchange of documents implies agreeing to the delegation of responsibility for maintaining the security of these documents and for providing the necessary audit and record keeping facilities.

### 1265 K.1 Security Environment

#### K.1.1 Threats

1270 Specific threats to the overall XDS system are listed below. These threats are identified using the Common Criteria nomenclature defined by ISO 17799. Most of these are mitigated by policies, procedures, and technologies that are not unique to XDS and do not require any special XDS considerations. Many of these mitigations do require that the parties within the XDS Affinity Domain have agreement on details of how they will work together.

**T.ADMIN\_ERROR** Improper administration may result in defeat of specific security features.

1275 **T.ADMIN\_ROGUE** Authorized administrator's intentions may become malicious resulting in TSF data to be compromised.

**T.AUDIT\_CORRUPT** A malicious process or user may cause audit records to be lost or modified, or prevent future records from being recorded by taking actions to exhaust audit storage capacity, thus masking an attacker's actions.

1280 **T.CONFIG\_CORRUPT** A malicious process or user may cause configuration data or other trusted data to be lost or modified.

**T.DISASTER** System or network may failure due to disaster (e.g., fire, earthquake).

**T.DOS** A malicious process or user may block others from system resources via a resource exhaustion denial of service attack.

1285 **T.EAVESDROP** A malicious process or user may intercept transmitted data inside or outside of the enclave. Some of the XDS environments are not concerned with eavesdrop exposure. They may employ external protective mechanisms such as physical network security or VPNs to protect against eavesdropping.

**T.HARDWARE** Hardware may malfunction.

- 1290 **T.IMPROPER\_INSTALLATION** XDS components may be delivered, installed, or configured in a manner that undermines security.
- T.INSECURE\_START** Reboot may result in insecure state of the operating system.
- T.INTRUSION** Malicious software (e.g., virus) may be introduced into the system.
- T.MASQUERADE** A malicious process or user on one machine on the network may masquerade as an entity on another machine on the same network.
- 1295 **T.OBJECTS\_NOT\_CLEAN** Systems may not adequately remove the data from objects between usage by different users, thereby releasing information to a user unauthorized for the data. This also includes swapping hard disk with PHI during service and repair.
- T.POOR\_DESIGN** Unintentional or intentional errors in requirement specification, design or development of the TOE components may occur.
- 1300 **T.POOR\_IMPLEMENTATION** Unintentional or intentional errors in implementing the design of the XDS environment may occur.
- T.POOR\_TEST** Incorrect system behavior may result from inability to demonstrate that all functions and interactions within the XDS operation are correct.
- 1305 **T.REPLAY** A malicious process or user may gain access by replaying authentication (or other) information.
- T.SPOOFING** A hostile entity may masquerade itself as part of the XDS Affinity Domain and communicate with authorized users who incorrectly believe they are communicating with authorized members.
- T.SYSACC** A malicious process or user may gain unauthorized access to the administrator account, or that of other trusted personnel.
- 1310 **T.UNATTENDED\_SESSION** A malicious process or user may gain unauthorized access to an unattended session.
- T.UNAUTH\_ACCESS** Unauthorized access to data by a user may occur. This includes access via direct user interaction with the device, access via network transactions, and access via removable electronic and printed media.
- 1315 **T.UNAUTH\_MODIFICATION** Unauthorized modification or use of XDS attributes and resources may occur.
- T.UNDETECTED\_ACTIONS** Failure of the XDS components to detect and record unauthorized actions may occur.
- 1320 **T.UNIDENTIFIED\_ACTIONS** Failure of the administrator to identify and act upon unauthorized actions may occur.
- T.UNKNOWN\_STATE** Upon failure of XDS components, the security of the XDS environment may be unknown.
- T.USER\_CORRUPT** User data may be lost or tampered with by other users.

1325 **K.1.2 Security and Privacy Policy**

There are a wide variety of security and privacy regulations established by law and regulation. These are interpreted and extended to create individual enterprise policies. This equipment will be installed into a variety of enterprises that are subject to a variety of laws and regulations. The XDS environment will provide support for the common aspects of these enterprise policies. The policy statements whose enforcement must be provided by the XDS security mechanisms are:

- 1330 **P.ACCOUNT** The users of the system shall be held accountable for their actions within the system.
- P.AUTHORIZATION** The system must limit the extent of each user's abilities in accordance with the TSPP. (See P.PATIENT\_CARE.)
- 1335 **P.AUTHORIZED\_USERS** Only those users who have been authorized to access the information within the system may access the system. (See P.PATIENT\_CARE.)
- P.CRYPTOGRAPHY** The system shall use standard approved cryptography (methods and implementations) for key management (i.e., generation, access, distribution, destruction, handling, and storage of keys) and cryptographic services (i.e., encryption, decryption, signature, hashing, key exchange, and random number generation services).
- 1340 **P.DECLARATIVE\_SECURITY** The system shall allow the administrator to define security related rules. Examples include defining access control policies and password expiration restriction.
- P.I\_AND\_A** All users must be identified and authenticated prior to accessing any controlled resources with the exception of public objects.
- 1345 **P.OBJECTAUTHORIZATION** The XDS components must enforce the policy regarding how authorization is established for protected objects. The policy determines how access control and other policies are enforced. (This is often considered part of P.Authorization, but in the XDS context it may make sense to consider this as a separate policy.)
- 1350 **P.PATIENT\_CARE** The security and privacy measures should not prevent patient care. In particular, there should be emergency bypass mechanisms to override security when necessary to provide patient care.
- P.SYSTEM\_INTEGRITY** The system must have the ability to periodically validate its correct operation and, with the help of Administrators, Backup and Restore Operators, and Service Personnel, it must be able to recover from any errors that are detected.
- 1355 **P.TRACE** The primary method for enforcing the security and privacy policy is the use of auditing. The XDS components must have the ability to review the actions of individuals. The XDS environment must provide sufficient audit information to external audit and monitoring systems to permit the review of actions of individuals by that other system.
- 1360 **P.TRUSTED\_RECOVERY** Procedures and/or mechanisms shall be provided to assure that, after a system failure or other discontinuity, recovery without a protection compromise is obtained

**P.VULNERABILITY\_SEARCH** The XDS environment must undergo an analysis for vulnerabilities beyond those that are obvious.

### 1365 **K.1.3 Security Usage Assumptions**

Assumptions of the use of the XDS environment:

**A.PHYSICAL** It is assumed that appropriate physical security is provided within the domain for the value of the IT assets and the value of the stored, processed, and transmitted information.

1370 **A. AUDIT\_REVIEW** It is assumed that there will be audit repository and review services provided that can accept audit information from the XDS components in real time.

**A.OPERATION** It is assumed that networks, firewalls, etc. are deployed and maintained to meet appropriate network security levels.

1375 **A.PERSONNEL** It is assumed that the organization can assure IT user & other workforce personal integrity/trustworthiness.

**A.PKI** It is assumed that there will be a facility to provide signed certificates as needed for node and user authentication. The key management maybe done manually or automatically depending on the availability of appropriate technology.

## **K.2 Security Objectives**

1380 This section defines the security objectives for the XDS environment. These objectives are suitable to counter all identified threats and cover all identified organizational security policies and assumptions. Common Criteria nomenclature is used. The XDS component security objectives are identified with “O.” appended to at the beginning of the name and the environment objectives are identified with “OE.” appended to the beginning of the name.

### 1385 **K.2.1 XDS Component Security Objectives**

**O.ACCESS** The XDS components will ensure that users gain only authorized access to it and to the resources that it controls. (See O.EMERGENCY\_BYPASS.)

**O.ACCESS\_HISTORY** The XDS components will display information (to authorized users) related to previous attempts to establish a session.

1390 **O.ADMIN\_ROLE** The XDS components will provide separate administrator roles to isolate administrative actions. These include a General Administrator role, a Backup and Restore Operator role, a Cryptographic Administrator role, and a Service Personnel role. Additional roles can be defined. These roles are collectively called Administrators.

1395 **O.ADMIN\_TRAINED** The XDS components will provide authorized Administrators with the necessary information for secure management and operation.

**O.AUDIT\_GENERATION** The XDS components will provide the capability to detect and create records of security and privacy relevant events associated with users. The XDS components will reliably transmit this information to the central audit repository, and provide

- 1400 reliable local storage of events until the central audit repository has confirmed receipt. (See OE.AUDIT\_REVIEW.)
- O.AUDIT\_PROTECTION** Each XDS component will provide the capability to protect audit information within its scope of control.
- O.AUDIT\_REVIEW** If an external central audit repository is not part of the environment, the components will be configured to provide limited capability to analyze and selectively view audit information. (See OE.AUDIT\_REVIEW)
- 1405 **O.CONFIG\_MGMT** All changes to the components and its development evidence will be tracked and controlled.
- O.DECLARATIVE\_SECURITY** The components will allow security functions and access control to be defined by the authorized administrator.
- 1410 **O.DISASTER\_RECOVERY** The components should allow the authorized Administrators to perform backup and restore of electronic data, and rapid configuration and reconfiguration of device operation. In addition, the TOE should support administrative procedures to restore operation after disasters that may have substantially destroyed portions of the hospital operation and where substitute temporary systems are in place.
- 1415 **O.DISCRETIONARY\_ACCESS** The components will control accesses to resources based upon the identity of users and the role of users. (See O.EMERGENCY\_BYPASS.)
- O.DISCRETIONARY\_USER\_CONTROL** The components will allow authorized users to specify which resources may be accessed by which users and groups of users. (See O.EMERGENCY\_BYPASS.)
- 1420 **O.EMERGENCY\_BYPASS** The XDS components should allow access to any secured data during a declared medical emergency.
- O.ENCRYPTED\_CHANNEL** Based on the environmental policies, encryption may be used to provide confidentiality of protected data in transit over public network.
- O.INSTALL** The XDS components will be delivered with the appropriate installation guidance in the form of installation manuals and training to establish and maintain component security.
- 1425 **O.INTRUSION\_DETECTION** The XDS components will ensure intrusion of malicious software (e.g., virus) is detected.
- O.MANAGE** The XDS components will provide all the functions and facilities necessary to support the authorized Administrators in their management of the security of the TOE.
- 1430 **O.PROTECT** The XDS components will provide means to protect user data and resources.
- O.RECOVERY** Procedures and/or mechanisms will be provided to assure that recovery is obtained without a protection compromise, such as from system failure or discontinuity.
- O.REMOTE\_SERVICE** The XDS components will provide the means for remote service
- 1435 without sacrificing security or privacy policy.

**O.RESIDUAL\_INFORMATION** The XDS components will ensure that any information contained in a protected resource is not released when the resource is reallocated. Information on permanent media such as hard disk shall be secured during service and repair.

**O.RESOURCE\_SHARING** No user will block others from accessing resources.

1440 **O.SELF\_PROTECTION** Each XDS component will maintain a domain for its own execution that protects itself and its resources from external interference, tampering, or unauthorized disclosure.

**O.TRAINED\_USERS** The XDS environment will provide authorized users with the necessary guidance for secure operation.

1445 **O.TRUSTED\_PATH** The TOE will provide a means to ensure users are not communicating with some other entity pretending to be the TOE. This covers entity authentication. (See O.USER\_AUTHENTICATION.)

**O.TRUSTED\_SYSTEM\_OPERATION** The XDS components will function in a manner that maintains security.

1450 **O.USER\_AUTHENTICATION** The XDS components will verify the claimed identity of the interactive user. (See O.ENTITY\_AUTHENTICATION.)

**O.USER\_IDENTIFICATION** The XDS components will uniquely identify the interactive users.

### K.2.2 Environment Security Objectives

1455 **OE.PHYSICAL** Physical security will be provided within the domain for the value of the IT assets protected by the XDS environment and the value of the stored, processed, and transmitted information.

1460 **OE.AUDIT\_REVIEW** There may be an audit repository and review service provided that can accept audit information from the XDS environment in real time. This facility will provide review and analysis functions. (See O.AUDIT\_GENERATION, O.AUDIT\_REVIEW.)

**OE.OPERATION** Networks, firewalls, etc. are deployed and maintained to meet appropriate network security levels.

**OE.PERSONNEL** Assure IT user & other workforce personal integrity/trustworthiness.

1465 **OE.PKI** There will be a facility to provide signed certificates as needed for node and user authentication.

### K.3 Functional Environment

1470 The XDS environment can be modeled as having four different organizations that have a delegated responsibility relationship where each organization has a different functional responsibility. In some configurations a single organization is responsible for two or more of these functions, which makes delegation much easier. This section discusses the major areas that must be solved.



The four functions are:

1475 **Creator** – This functional organization has created the PHI and is legally responsible to the patient and others for providing healthcare and for protecting this data.

**Repository** – This functional organization is responsible for providing access to persistent documents to readers. The creator has delegated responsibility to the repository to provide adequate protection for a subset of the PHI. This subset is called the document.

1480 **Registry** - This functional organization is responsible for providing query services to readers. The creator has delegated responsibility to the registry to provide adequate protection for a subset of the PHI. This subset is called the metadata.

**Reader** – This functional organization is providing healthcare services that make use of data that is contained in the metadata and the documents.

There are three levels of difficulty in delegation.

1485 **“Trivial”** delegation is that where it is not necessary to delegate the responsibility for implementing the threat mitigation. In those cases it does not matter whether the organizations have the same policy or mitigations. For example, if the registry provides adequate mitigation against the threat of disaster, it need not be concerned with the disaster related policies of the reader.

1490 **“Easy”** delegation is that where the two organizations have the equivalent policies. In those cases there is an initial difficult phase of discovering that the policies are the same and evaluating that the mitigation strategies are acceptable. This results in a simple binary decision to approve or disapprove a business relationship permitting the exchange of data. With the exception of the three policy classes described as “hard” below, the details of policies are likely to differ, but the goals are sufficiently uniform that a simple business decision can be made.

1495 For the “easy” delegation, the IHE transactions must provide adequate mitigations for the threats so that the business decision to exchange data can be made based simply on review of the partners policies and mitigations. This means that some IHE transactions will have additional security requirements attached. For example, encryption to avoid the threat of eavesdropping may be required. These requirements are not unique to XDS and will be able to use standardized security features like TLS and VPN tools. These requirements may be significantly different from the usual practice within an enterprise, because of the differences in the environment.

1500 **“Hard”** delegation is that where the two organizations have different policies or inconsistent/incompatible mitigation strategies. These are likely to occur for the following policies, where organizations often disagree on the details of the policy goals, and where policies often change:

1510 **P.Authorization** – The authorized access policies and authorized modification policies often differ, and are often subject to change. The changes that occur are often at a detailed level, e.g., access rights to a particular patient information may change. This means that either there is an agreed mechanism to propagate changes, or an acceptance that policy changes may not be enforced, or there will be restrictions on the data exchange to avoid delegating responsibility for data that is subject to change.

1515 **P.Account** and **P.Trace** – The policies for accountability and traceability often differ. These are much less subject to change, but it is often difficult to reconcile delegation when these policies differ. This will be an especially difficult issue for repository and registry functions that support multiple different creator organizations.

1520 **P.ObjectAuthorization** – The policies regarding creation and modification of access rights often differ. In addition, any of the policy and threat mitigations may be determined to be unacceptable by creator, registry, or repository. In the simple situation where there are only four real world participants this simply means that there is no business relationship. In the more complex world where the registry or repository are in many relationships with many creators and readers it introduces a serious problem. Either the registry and repository must limit its relationship to that small set of creators and readers that mutually accept all the policies and mitigations of all the other organizations, or there must be a mitigation strategy so that creators can restrict delegations  
1525 by the registry and repository to only those readers that have policies and mitigations that are acceptable to the creator.

Mitigations for differences include the following:

1530 Limit the data exchange to that data where the differences are not significant. For example, highly sensitive data like psychiatric notes might not be shared, while relatively insignificant data like allergy information is shared.

1535 Provide a revocation mechanism to deal with policy changes, so that future delegations can be prohibited. It is often impractical to revoke past delegations because the PHI has already been disclosed. But the revocation mechanism can stop further delegation from taking place. This revocation mechanism must be part of the P.Authorization and P.ObjectAuthorization policies and must be mutually acceptable for this mitigation to be effective.

Trusted third party inspections and audits can sometimes deal with reconciliation of differences in P.Account and P.Trace.

1540 An “approved delegation” list identifying acceptable and unacceptable creator/reader pairs can mitigate the repository and registry issues when the reader has incompatible policies with the creator. This does require the creator to accept the approved delegation policy and implementation of the repository and registry, but it reduces the combinatorial explosion of policy combinations between creators, repositories, registries, and readers into a linear growth in complexity.

1545 The “approved delegation” may go further into identification of persons, but this is only a viable path when all parties have policies the easily support delegation of personal responsibility. Persons are usually required to comply with organizational policies, and organizations generally use roles rather than persons to establish policies. The often viable exception is the special case of the “deny access to person X”. This can be a viable means of dealing with situations involving a conflict of interest. This kind of access denial may be applicable to just a particular subset of  
1550 the PHI exchanged, (e.g., denying access to an ex-spouse).

These mitigations do not directly change the technical requirements for the XDS transactions. They are policy decisions that may affect how particular actors are configured. The implementation of XDS actors will need to be aware that this kind of site-specific configuration management and policy control will be routinely required.

1555 **Appendix L: Relationship of Document Entry Attributes and Document Headers**

For DocumentEntry relationship to Document Content, please see the PCC TF-2: 4 or a specific Document Content Profile.

## Appendix M: Using Patient Demographics Query in a Multi-Domain Environment

1560

### M.1 HL7 QBP^Q22 Conformance Model

The HL7 Find Candidates Query (QBP^Q22) defines a patient demographics query between a client application and an MPI system (HL7 V2.5, Page 3-64). This implies that the server maintains a master record of the patient demographics, but may know a number of patient identifiers from other domains.

1565

In the QBP^Q22 Conformance Statement, QPD-8 (What Domains Returned) is defined as “the set of domains for which identifiers are returned in PID-3” (HL7 V2.5, Page 3-66, second table). Note that this field does not cite “demographics information in some domains”, but about “identifiers issued in some domains”, and explicitly specifies that these identifiers are returned in PID-3 (Patient ID List).

1570

In the example following the Conformance Statement in HL7 2.5, three patient records are included in the query response; each returned patient record includes two identifiers in PID-3 (domains METRO HOSPITAL and SOUTH LAB) as requested in the query. However, one set of demographic information is returned in the remainder of the PID segment. The example does not illustrate or assume a mechanism for returning multiple sets of demographic information.

1575

Thus it appears that QBP^Q22 is not intended to provide a way to issue a single query for patient demographics maintained in multiple different patient registration systems (domains).

### M.2 IHE PDQ Architecture

In the PDQ Integration Profile, the supplier is characterized as a Patient Demographics Supplier. The supplier is not assumed nor required to be an MPI system. It may be holding information from only a single patient identification domain, or may instead hold information from multiple identification domains.

1580

The latter case would apply if, for example, the Patient Demographics Supplier is grouped with an actor accepting ADT feeds from multiple patient registration systems in different domains. Equivalently, the Patient Demographics Supplier (or some other actor with which it is grouped) may manage a set of patient demographics sources, but is not expected to cross-reference them (as a PIX Patient Identifier Cross-reference Manager or an MPI system). A conceptual model embracing both multi-domain concepts is shown in the following picture.

1585

1590

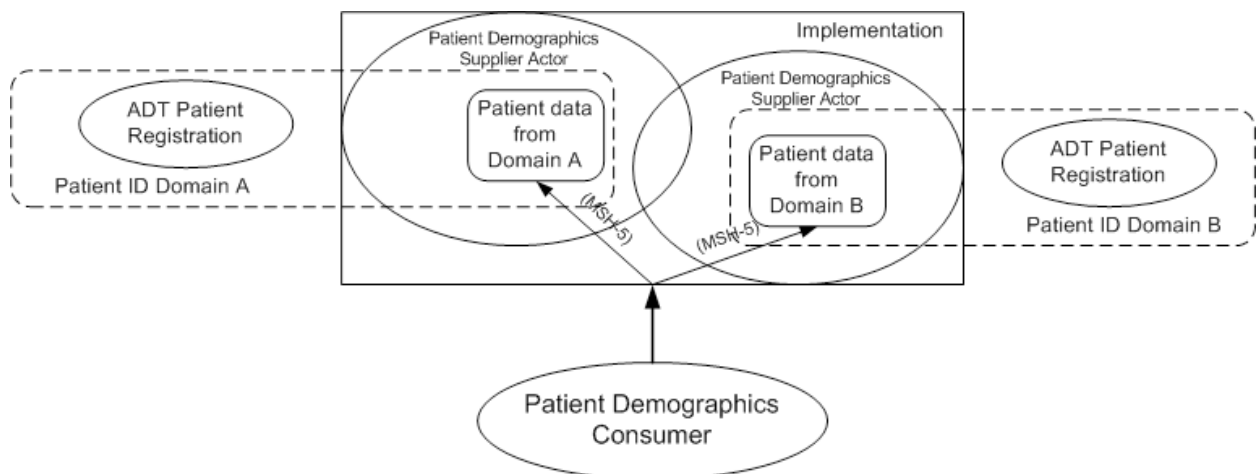

**Figure M.2-1: Patient Demographics Supplier in a Multi-domain Environment**

1595 Because of the definition of QBP^Q22, it must be determined which patient demographics  
 1600 source a QBP^Q22 query is asking for, before any processing of the query request can proceed.  
 The identification of a need for such determination is the key difference between the IHE PDQ  
 transactions and the original HL7 QBP^Q22 definitions.

Three obvious alternatives exist for determining the patient demographics source.

- 1600 1. The supplier advertises different application entities for each of the patient demographics  
 sources it manages. By addressing its query to a particular application entity in *MSH-5-  
 Receiving Application*, the consumer explicitly selects a source it is asking for.
2. The consumer is required to populate PID-3.4 in QPD-3 (Query Parameter) with the  
 domain name administered by the corresponding source (patient identifier domain) it is  
 asking for.
- 1605 3. The consumer includes in QPD-8 (What Domains Returned) the domain name of the  
 corresponding patient information source it is asking for.

1610 In selecting among these alternatives for the PDQ Profile, IHE-ITI took into account the need to  
 constrain the current HL7 QBP^Q22 definition while maintaining the integrity of the HL7  
 standard query and at the same time to model the PDQ Profile properly to satisfy its real-world  
 purpose. Based on these considerations, alternative 1 is the best selection, although alternative 2  
 is acceptable. Alternative 3 is not acceptable because it violates the definition of QPD-8 that is  
 stated in the HL7 Standard.

### M.3 Implementing PDQ in a multi-domain architecture

There are three possible approaches in using PDQ in a multi-domain environment:

- 1615 1. Group the PDQ Patient Demographics Supplier with a PIX Patient Identifier Cross-  
 reference Manager. This allows the use of QPD-8 to request *patient identifiers* from other  
 domains to be returned in the demographics query response to the PDQ Patient  
 Demographics Consumer.

- 1620           2. Group the PDQ Patient Demographics Supplier with a PIX Patient Identifier Cross-reference Consumer. This allows the use of QPD-8 to request *patient identifiers* from other domains to be returned in the demographics query response to the PDQ Patient Demographics Consumer.
- 1625           3. Group the PDQ Patient Demographics Consumer with a PIX Patient Identifier Cross-reference Consumer. This obliges the Patient Demographics Consumer to use separate query requests to obtain patient demographics information (PDQ Query) and patient identifiers from the domains in which it is interested (PIX Query).

Approach 3 is not recommended if Approach 1 or 2 is feasible. To require the Patient Demographics Consumer to issue a separate PIX query increases complexity and might not be permissible in the actual implementation architecture.

- 1630           When Approach 1 or 2 is implemented, QPD-8 may be used by the Patient Demographics Consumer to ask for patient identifiers from the single domain used to identify patients in the Affinity Domain. The patient demographics information returned comes from the patient demographics source that is associated with *MSH-5-Receiving Application*; the patient demographics source may or may not be associated with the patient identifier domain.
- 1635           In Approach 2, note that the PDQ Patient Demographics Supplier is grouped with the PIX Patient Identifier Cross-reference Consumer. This combined actor will use a PIX query to satisfy the request of the client from additional patient identifiers and return them in PID-3.

## Appendix N: Common Data Types

1640 This section describes IHE constraints of commonly used HL7 data types.

### N.1 CX Data Type

This data type definition is not used in [ITI-8], [ITI-9], or [ITI-10]. See Appendix E for the rules for those transactions.

CX: Extended Composite ID with check digit

SEQ	LEN	DT	Usage	CARD	TBL#	COMPONENT NAME
1	15	ST	R	[1..1]		ID Number
2	1	ST	O	[0..1]		Check Digit
3	3	ID	O	[0..1]	0061	Check Digit Scheme
4	227	HD	R	[1..1]	0363	Assigning Authority
5	5	ID	RE	[0..1]	0203	Identifier Type Code
6	227	HD	O	[0..1]		Assigning Facility
7	8	DT	O	[0..1]		Effective Date
8	8	DT	O	[0..1]		Expiration Date
9	705	CWE	O	[0..1]		Assigning Jurisdiction
10	705	CWE	O	[0..1]		Assigning Agency or Department

1645

The constraints above particularly apply to the Patient Identifiers carried in the PID segment.

The data type has been constrained because the IHE Framework regards the Assigning Authority and the Identifier Type Code as essential components.

1650 A common value of the Identifier Type Code for a Patient Identifier assigned by the healthcare organization (PID-3) is “PI”. Other values are defined in Table 0203 of HL7 2.5 Section 2.A.17.5.

Example: 12345^^^Saint-John Hospital^PI

The Identifier Type Code for Patient Account Number (PID-18) is “AN”.

### N.2 EI Data Type

1655 EI: Entity Identifier

SEQ	LEN	DT	Usage	CARD	TBL#	COMPONENT NAME
1	16	ST	R	[1..1]		Entity Identifier
2	20	IS	C	[0..1]	0363	Namespace ID
3	199	ST	C	[0..1]		Universal ID
4	6	ID	C	[0..1]	0301	Universal ID Type

Component 1 is required. Either component 2 or both components 3 and 4 are required. Components 2, 3 and 4 may be all present.

1660 The EI is appropriate for machine or software generated identifiers. The generated identifier goes in the first component. The remaining components, 2 through 4, are known as the assigning authority; they can also identify the machine/system responsible for generating the identifier in component 1.

Example 1: AB12345^RiversideHospital

Example 2: AB12345^^1.2.840.45.67^ISO

Example 3: AB12345^RiversideHospital^1.2.840.45.67^ISO

1665 IHE constrains the length of the first component to 16 characters. National extensions can extend this length up to a maximum of 199.

IHE recommends that Component 2, “Namespace ID,” always be populated. Particularly when there are several concurrent assigning authorities within the healthcare enterprise, this Namespace ID will indicate which assigning authority provided the identifier in Component 1.

### 1670 N.3 HD Data Type

This data type definition is not used in [ITI-8], [ITI-9], or [ITI-10]. See Appendix E for the rules for those transactions.

HD: Hierarchic designator

SEQ	LEN	DT	Usage	CARD	TBL#	COMPONENT NAME
1	20	IS	R	[1..1]	0300	Namespace ID
2	199	ST	C			Universal ID
3	6	ID	C		0301	Universal ID Type

1675 IHE requires that a field of Data Type HD be populated with:

- Either the first component “Namespace ID” alone, which in this case contains a local identifier of the object.
- Or with all three components, “Namespace ID” containing the name of the object, “Universal ID” containing its universal OID, and “Universal ID Type” containing the value ISO.

1680

This data type is particularly used in this profile to identify facilities, applications and assigning authorities: sending and receiving applications, sending and receiving facilities, last update facility, assigning authority of an identifier, etc.

### N.4 PL data Type

1685 PL: Person Location

SEQ	LEN	DT	Usage	CARD.	TBL#	COMPONENT NAME
1	20	IS	O	[0..1]	0302	Point of Care
2	20	IS	O	[0..1]	0303	Room
3	20	IS	O	[0..1]	0304	Bed



SEQ	LEN	DT	Usage	CARD.	TBL#	COMPONENT NAME
4	227	HD	O	[0..1]		Facility
5	20	IS	O	[0..1]	0306	Location Status
6	20	IS	C	[0..1]	0305	Person Location Type
7	20	IS	O	[0..1]	0307	Building
8	20	IS	O	[0..1]	0308	Floor
9	199	ST	O	[0..1]		Location Description
10	427	EI	O	[0..1]		Comprehensive Location Identifier
11	227	HD	O	[0..1]		Assigning Authority for Location

Comments on some components:

Component 1: Point of Care (IS):

1690 HL7 definition: This component specifies the code for the point where patient care is administered. It is conditional on PL.6 Person Location Type (e.g., nursing unit or department or clinic). After floor, it is the most general patient location designation.

HL7 user-defined Table 0302 does not suggest any value. The codification of point of cares will be defined at the site level in acute care settings.

Component 4: Facility (HD):

1695 HL7 definition: This component is subject to site interpretation but generally describes the highest level physical designation of an institution, medical center or enterprise. It is the most general person location designation.

1700 The codification of facilities will be defined at the highest level, according to the context of use of the PAM Profile (community affinity domain, acute care setting, ambulatory domain, etc.).

Component 6: Person Location Type (IS):

1705 HL7 definition: Person location type is the categorization of the person's location defined by facility, building, floor, point of care, room or bed. Although not a required field, when used, it may be the only populated field. It usually includes values such as nursing unit, department, clinic, SNF, physician's office. Refer to *User-defined Table 0305 - Person location type* for suggested values.

**User-defined Table 0305 – Person location type**

Value	Description	Comment
C	Clinic	
D	Department	
H	Home	
N	Nursing Unit	
O	Provider's Office	
P	Phone	

Value	Description	Comment
S	SNF	

National extensions may further constrain or extend this table.

## 1710 N.5 TS Data Type

TS: Time Stamp

SEQ	LEN	DT	Usage	CARD	TBL#	COMPONENT NAME
1	24	DTM	R	[1..1]		Time
2	1	ID	X	[0..0]	0529	Degree of Precision

The first subfield is required. It specifies a point in time.

Maximum length: 24.

1715 HL7 Format: YYYY[MM[DD[HH[MM[SS[.S[S[S[S]]]]]]]]][+/-ZZZZ]

Constrained format in the PAM Profile: YYYY[MM[DD[HH[MM[SS]]]]][+/-ZZZZ]

The least precise date possible is YYYY (only the year).

The most precise date possible is YYYYMMDDHHMMSS (up to the second).

1720 The time zone (+/-ZZZZ) is represented as +/-HHMM offset from Coordinated Universal Time (UTC), (formerly Greenwich Mean Time (GMT)), where +0000 or -0000 both represent UTC (without offset).

Note that if the time zone is not included, the time zone defaults to the local time zone of the sender.

1725 The second subfield is deprecated in HL7 v2.5, and therefore is not supported by the PAM Profile.

## N.6 XPN Data Type

XPN: Extended Person Name

SEQ	LEN	DT	USAGE	CARD	TBL#	COMPONENT NAME
1	194	FN	RE	[0..1]		Family Name
2	30	ST	O	[0..1]		Given Name
3	30	ST	O	[0..1]		Second and Further Given Names or Initials Thereof
4	20	ST	O	[0..1]		Suffix (e.g., JR or III)
5	20	ST	O	[0..1]		Prefix (e.g., DR)
6	6	IS	X	[0..0]	0360	Degree (e.g., MD)
7	1	ID	R	[1..1]	0200	Name Type Code
8	1	ID	O	[0..1]	0465	Name Representation Code
9	483	CE	O	[0..1]	0448	Name Context

SEQ	LEN	DT	USAGE	CARD	TBL#	COMPONENT NAME
10	53	DR	X	[0..0]		Name Validity Range
11	1	ID	O	[0..1]	0444	Name Assembly Order
12	26	TS	O	[0..1]		Effective Date
13	26	TS	O	[0..1]		Expiration Date
14	199	ST	O	[0..1]		Professional Suffix

1730 This data type is usually in a repeatable field, to allow a list of names. Examples: Legal name, display name.

Subfield 1 “Family Name” is required if known to the sender.

Subfield 7 “Name Type Code” is required. The PAM Profile allows these values from *HL7 Table 0200 – Name type*:

**HL7 Table 0200: Name type**

Value	Description	Comment
A	Alias Name	
B	Name at Birth	
C	Adopted Name	
D	Display Name	
I	Licensing Name	
L	Legal Name	
M	Maiden Name	
N	Nickname /”Call me” Name/Street Name	
R	Registered Name (animals only)	
S	Coded Pseudo-Name to ensure anonymity	
T	Indigenous/Tribal/Community Name	
U	Unspecified	

1735

This table may be further defined and restrained in national extensions.

Subfields 6 (Degree) and 10 (Name Validity Range) are deprecated in HL7 v2.5, and therefore is not supported by the PAM Profile.

1740 **Appendix O: HL7 v3 Transmission and Trigger Event Control Act Wrappers**

An HL7 Version 3 Interaction is composed of 2 parts:

1. An "HL7 Transmission wrapper(s)" (always)
2. The "HL7 Transmission Content" (optional)

1745 **O.1 HL7 V3 Transmission Wrappers**

An "HL7 Transmission wrapper" includes information needed by a sending application or message handling service to package and route the V3 interaction to the designated receiving application(s) and/or message handling service(s). This wrapper also includes attributes that influence the message handling behavior of the receiving application that is consistent with the HL7 defined messaging interaction for which the interaction has been created.

*Note: These wrappers loosely equate to the MSH, MSA, and ERR segments in HL7 v2.5.*

All HL7 Version 3 interactions have an appropriately configured "HL7 Transmission wrapper".

The HL7 Transmission Wrapper exists in two different forms:

- 1755 1. The Message Transmission Wrapper. This wrapper contains zero or one instances of HL7 Transmission Content.
2. The Batch Transmission Wrapper. This wrapper contains zero or more Message Transmission Wrappers. Each Message Transmission Wrapper contains zero or one instances of HL7 Transmission Content. The Batch wrapper is occasionally used to group Message Transmissions.

1760 An interaction that has the Message Transmission Wrapper as its "outermost" wrapper is commonly referred to as a "message" or a "message-based interaction". An interaction that has the Batch Transmission Wrapper as its "outermost" wrapper is commonly referred to as a "batch" or a "batch-based interaction".

1765 For the Refined Message Information Models, Hierarchical Message Definitions and Message Type Table Views, refer to:

[http://hl7.org/v3ballot2007may/html/domains/uvci/uvci\\_GenericMessageTransmission.htm](http://hl7.org/v3ballot2007may/html/domains/uvci/uvci_GenericMessageTransmission.htm)

**O.1.1 Send Message Payload Information Model (MCCI\_RM000100IHE)**

1770 Below is the Message Information Model for this transmission wrapper. The purpose of the model is to describe the data elements relevant for use with IHE transactions based on HL7 V3 messages. It is a strict subset of the Send Message Payload (MCCI\_RM000100UV01) RMIM, which can be found on the HL7 V3 2008 Edition CD at:  
Edition2008/domains/uvci/editable/MCCI\_RM000100UV.htm

The following restrictions were made on the original RMIM to arrive at the restricted model:

- 1775 • The following optional class attributes have been omitted:
  - Message.profileId

- Message.responseCode
- Message.attachmentText
- Sender.telecom
- Receiver.telecom
- 1780 ○ Device.desc
- Device.existenceTime
- The following optional classes have been omitted:
  - AttentionLine
  - RespondTo
  - 1785 ○ LocatedEntity
  - scopedRole(Organization)

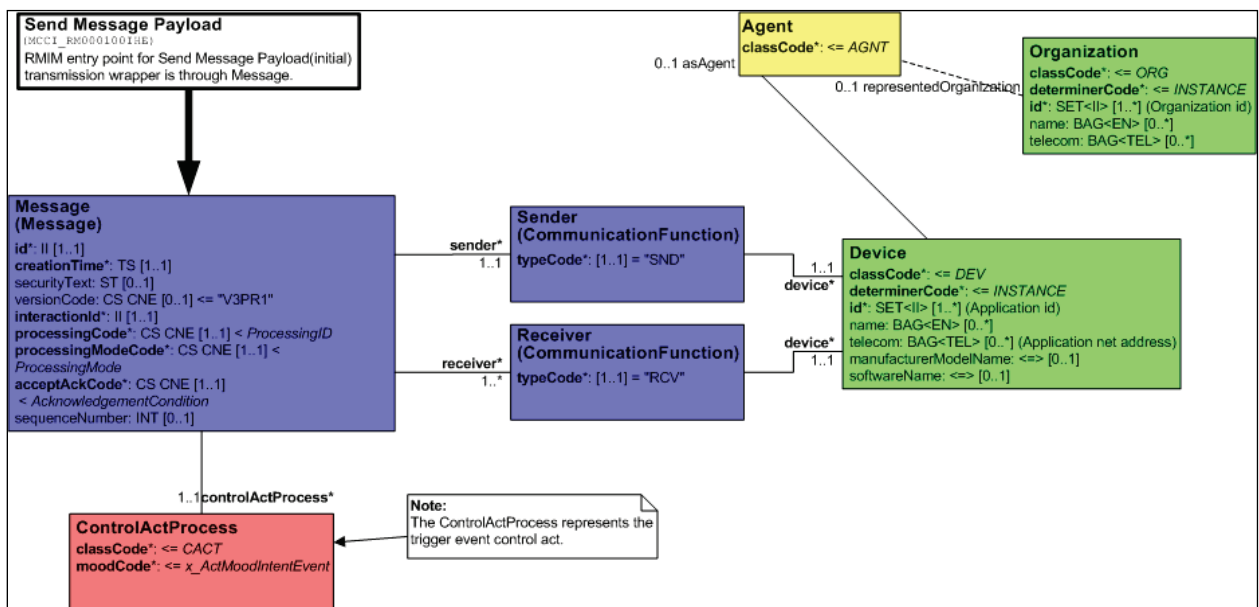

Figure O.1.1-1: Message Information Model

1790 The attributes of this model are described in the following table.

Table O.1.1-1: Model Attributes

<b>MCCI_HD000100IHE Send Message Payload</b>	<b>This HMD extract defines the transmission wrapper used to send HL7 V3 Message Payload. Derived from Figure O.1.1-1 (MCCI_RM000100IHE)</b>
<b>Message</b>	The transmission focal class. According of the XML ITS, the root XML element representing this class will be the HL7 interaction ID

<b>MCCI_HD000100IHE Send Message Payload</b>	<b>This HMD extract defines the transmission wrapper used to send HL7 V3 Message Payload. Derived from Figure O.1.1-1 (MCCI_RM000100IHE)</b>
id [1..1] (M) Transmission (II)	Unique message ID
creationTime [1..1] (M) Transmission (TS)	Time stamp representing the time the message was created. Note that this is different from the time when the event which triggered the message occurred.
versionCode [0..1] Message (CS) {CNE:HL7StandardVersionCode, default= "V3PR1"}	The HL7 Version used in this message
interactionId [1..1] (M) Message (II)	The HL7 Interaction ID represented by this message
processingCode [1..1] (M) Message (CS) {CNE:ProcessingID}	This attribute defines whether the message is part of a production, training, or debugging system. Valid values are D (Debugging), T (Testing), P (Production) – see <a href="http://hl7.org/v3ballot2007may/html/infrastructure/vocabulary/ProcessingID.htm">http://hl7.org/v3ballot2007may/html/infrastructure/vocabulary/ProcessingID.htm</a>
processingModeCode [1..1] (M) Message (CS) {CNE:ProcessingMode}	This attribute defines whether the message is being sent in current processing, archive mode, initial load mode, restore from archive mode, etc. Valid values are A (Archive), T (Current processing), I (Initial Load), R (Restore from archive) – see <a href="http://hl7.org/v3ballot2007may/html/infrastructure/vocabulary/ProcessingMode.htm">http://hl7.org/v3ballot2007may/html/infrastructure/vocabulary/ProcessingMode.htm</a>
acceptAckCode [1..1] (M) Message (CS) {CNE:AcknowledgementCondition}	Acknowledgement Condition codes describe the conditions under which accept or application level acknowledgements are required to be returned in response to the message send operation. Valid values are AL (Always), ER (Error/reject only), NE (Never).
sequenceNumber [0..1] Message (INT)	An optional sequence number.
<b>Sender</b>	
typeCode [1..1] (M) CommunicationFunction (CS) {CNE:SND, fixed value= "SND"}	Structural attribute; this is a "Sender" communication function
<b>Receiver</b>	
typeCode [1..1] (M) CommunicationFunction (CS) {CNE:RCV, fixed value= "RCV"}	Structural attribute; this is a "Receiver" communication function
<b>Device</b>	
classCode [1..1] (M) Entity (CS) {CNE:DEV, default= "DEV"}	Structural attribute; this entity is a "Device"
determinerCode [1..1] (M) Entity (CS) {CNE:INSTANCE, fixed value= "INSTANCE"}	Structural attribute; this is a specific device
id [1..*] (M) Entity (SET<II>)	The application ID(s). IHE restriction: id.root SHALL be an ISO OID, and id.extension SHALL NOT have a value.
name [0..*] Entity (BAG<EN>)	Optional Sender or Receiver name
telecom [0..*] Entity (BAG<TEL>)	Optional network address of the application
manufacturerModelName [0..1] Device (SC)	Optional application brand name
softwareName [0..1] Device (SC)	Optional software name

<b>MCCI_HD000100IHE Send Message Payload</b>	<b>This HMD extract defines the transmission wrapper used to send HL7 V3 Message Payload. Derived from Figure O.1.1-1 (MCCI_RM000100IHE)</b>
<b>Agent</b>	This role links the application with the organization to which it belongs
classCode [1..1] (M) Role (CS) {CNE:AGNT, default="AGNT"}	Structural attribute; this is the Agent role
<b>Organization</b>	The sender or receiver organization
classCode [1..1] (M) Entity (CS) {CNE:ORG, default="ORG"}	Structural attribute; this entity is an organization
determinerCode [1..1] (M) Entity (CS) {CNE:INSTANCE, fixed value="INSTANCE"}	Structural attribute; this is a specific organization
id [1..*] (M) Entity (SET<II>)	The organization ID(s). IHE restriction: id.root SHALL be an ISO OID, and id.extension SHALL NOT have a value.
name [0..*] Entity (BAG<EN>)	Optional organization name
telecom [0..*] Entity (BAG<TEL>)	Optional telecommunications address
<b>ControlActProcess</b>	This is the stub where the focal class of the transmission content will be placed in the message.

### O.1.2 Send Accept Acknowledgement Information Model (MCCI\_RM000200IHE)

1795 Below is the Message Information Model for the accept acknowledgment. The purpose of the model is to describe the data elements relevant for use with IHE transactions based on HL7 V3 messages. It is a strict subset of the Send Accept Acknowledgement (MCCI\_RM000200UV01) RMIM, which can be found on the HL7 V3 2008 Edition CD at: [Edition2008/domains/uvci/editable/MCCI\\_RM000200UV.htm](Edition2008/domains/uvci/editable/MCCI_RM000200UV.htm)

The following restrictions were made on the original RMIM to arrive at the restricted model:

- 1800
- The following optional class attributes have been omitted:
    - Message.profileId
    - Message.attachmentText
    - Sender.telecom
    - Receiver.telecom
- 1805
- Device.desc
  - Device.existenceTime
  - Acknowledgement.messageWaitingNumber
  - Acknowledgement.messageWaitingPriorityCode
  - The following optional classes have been omitted:

- 1810
- AttentionLine
  - RespondTo
  - LocatedEntity
  - scopedRole(Organization)
  - The following constraints have been applied:
- 1815
- Message.acceptAckCode is fixed to NE (don't ack an ack)
  - Acknowledgment is a required class

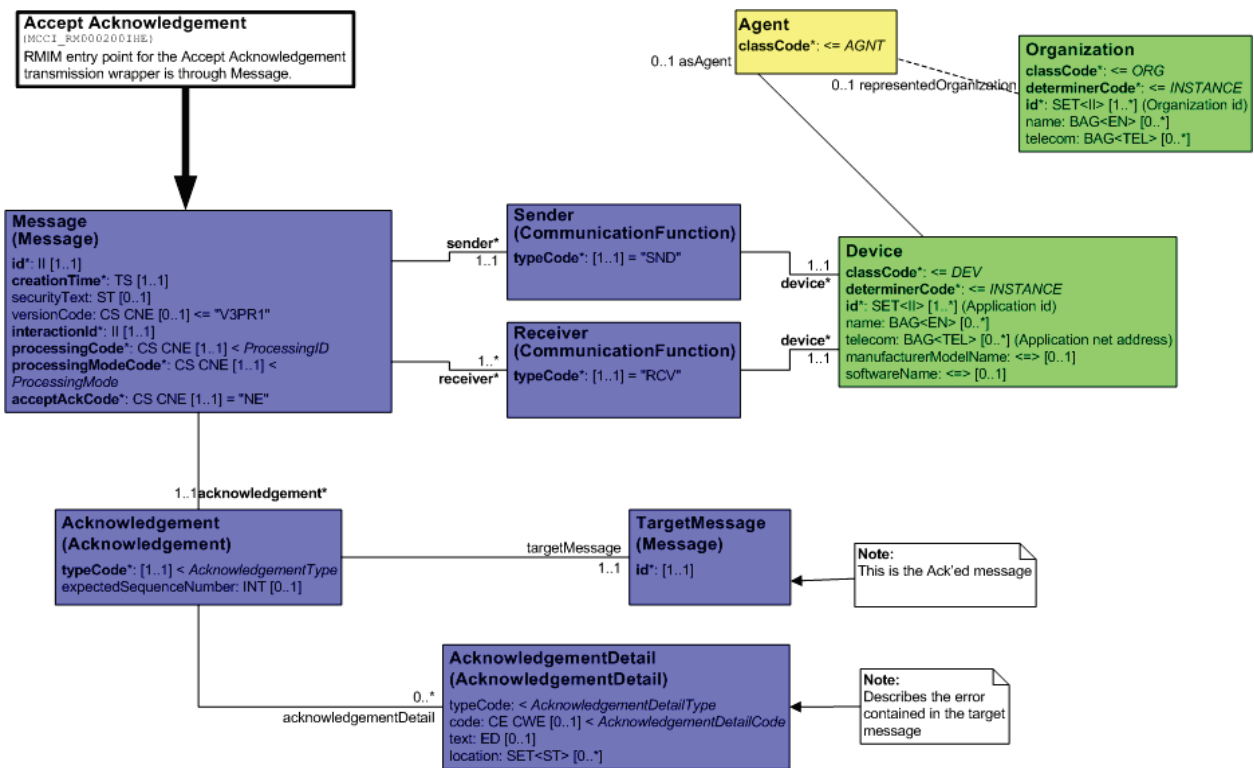

Figure O.1.2-1: Message Information Mode;

1820 The attributes of this model are described in the following table:

Table O.1.2-1: Model Attributes

MCCI_HD000200IHE Send Accept Acknowledgement	This HMD extract defines the transmission wrapper used to send HL7 V3 Accept Acknowledgement. Derived from Figure O.1.2-1 (MCCI_RM000200IHE)
<b>Message</b>	The transmission focal class. According of the XML ITS, the root XML element representing this class will be the HL7 interaction ID
id [1..1] (M) Transmission (II)	Unique message ID of the acknowledgment



<b>MCCI_HD000200IHE Send Accept Acknowledgement</b>	<b>This HMD extract defines the transmission wrapper used to send HL7 V3 Accept Acknowledgement. Derived from Figure O.1.2-1 (MCCI_RM000200IHE)</b>
creationTime [1..1] (M) Transmission (TS)	Time stamp representing the time the message was created. Note that this is different from the time when the event which triggered the message occurred.
versionCode [0..1] Message (CS) {CNE:HL7StandardVersionCode, default= "V3PR1"}	The HL7 Version used in this message
interactionId [1..1] (M) Message (II)	The HL7 Interaction ID represented by this message
processingCode [1..1] (M) Message (CS) {CNE:ProcessingID}	This attribute defines whether the message is part of a production, training, or debugging system. Valid values are D (Debugging), T (Testing), P (Production) – see <a href="http://hl7.org/v3ballot2007may/html/infrastructure/vocabulary/ProcessingID.htm">http://hl7.org/v3ballot2007may/html/infrastructure/vocabulary/ProcessingID.htm</a>
processingModeCode [1..1] (M) Message (CS) {CNE:ProcessingMode}	This attribute defines whether the message is being sent in current processing, archive mode, initial load mode, restore from archive mode, etc. Valid values are A (Archive), T (Current processing), I (Initial Load), R (Restore from archive) – see <a href="http://hl7.org/v3ballot2007may/html/infrastructure/vocabulary/ProcessingMode.htm">http://hl7.org/v3ballot2007may/html/infrastructure/vocabulary/ProcessingMode.htm</a>
acceptAckCode [1..1] (M) Message (CS) {CNE:AcknowledgementCondition, fixed="NE"}	Acknowledgement Condition codes describe the conditions under which accept or application level acknowledgements are required to be returned in response to the message send operation. Fixed to NE (Never) as this is an acknowledgment itself.
<b>Sender</b>	The sender is the one which is acknowledging the receipt of a message
typeCode [1..1] (M) CommunicationFunction (CS) {CNE:SND, fixed value= "SND"}	Structural attribute; this is a "Sender" communication function
<b>Receiver</b>	The receiver in the one which sent the message being acknowledged
typeCode [1..1] (M) CommunicationFunction (CS) {CNE:RCV, fixed value= "RCV"}	Structural attribute; this is a "Receiver" communication function
<b>Device</b>	
classCode [1..1] (M) Entity (CS) {CNE:DEV, default= "DEV"}	Structural attribute; this entity is a "Device"
determinerCode [1..1] (M) Entity (CS) {CNE:INSTANCE, fixed value= "INSTANCE"}	Structural attribute; this is a specific device
id [1..*] (M) Entity (SET<II>)	The application ID(s). IHE restriction: id.root SHALL be an ISO OID, and id.extension SHALL NOT have a value.
name [0..*] Entity (BAG<EN>)	Optional Sender or Receiver name
telecom [0..*] Entity (BAG<TEL>)	Optional network address of the application
manufacturerModelName [0..1] Device (SC)	Optional application brand name
softwareName [0..1] Device (SC)	Optional software name
<b>Agent</b>	This role links the application with the organization to which it belongs
classCode [1..1] (M) Role (CS) {CNE:AGNT, default= "AGNT"}	Structural attribute; this is the Agent role

<b>MCCI_HD000200IHE</b> <b>Send Accept Acknowledgement</b>	<b>This HMD extract defines the transmission wrapper used to send HL7 V3</b> <b>Accept Acknowledgement.</b> <b>Derived from Figure O.1.2-1 (MCCI_RM000200IHE)</b>
<b>Organization</b>	The sender or receiver organization
classCode [1..1] (M) Entity (CS) {CNE:ORG, default="ORG"}	Structural attribute; this entity is an organization
determinerCode [1..1] (M) Entity (CS) {CNE:INSTANCE, fixed value="INSTANCE"}	Structural attribute; this is a specific organization
id [1..*] (M) Entity (SET<II>)	The organization ID(s). IHE restriction: id.root SHALL be an ISO OID, and id.extension SHALL NOT have a value.
name [0..*] Entity (BAG<EN>)	Optional organization name
telecom [0..*] Entity (BAG<TEL>)	Optional telecommunications address
<b>Acknowledgement</b>	
typeCode [1..1] (M) Acknowledgement (CS) {CNE:AcknowledgementType}	The acknowledgement type. Since this is an Accept Acknowledgement, the possible values are CA (Accept Acknowledgement Commit Accept), CE (Accept Acknowledgement Commit Error), or CR (Accept Acknowledgement Commit Reject).
expectedSequenceNumber [0..1] Acknowledgement (INT)	
<b>TargetMessage</b>	The message being acknowledged
id [1..1] (M) Transmission (II)	Unique message ID of the message being acknowledged
<b>AcknowledgementDetail</b>	Describes the error(s) contained in the target message
typeCode [0..1] AcknowledgementDetail (CS) {CNE:AcknowledgementDetailType}	Optional detail type indicating if the problem was an error (E), a warning (W), or informational (I).
code [0..1] AcknowledgementDetail (CE) {CWE:AcknowledgementDetailCode}	An optional coded value, representing the acknowledgement detail being transmitted.
text [0..1] AcknowledgementDetail (ED)	Optional description of the acknowledgement detail being transmitted
location [0..*] AcknowledgementDetail (SET<ST>)	The location within the message where the problem occurred. It is recommended that this is represented via an XPath expression.

The Accept Acknowledgement does not contain any additional content defined elsewhere. It will be transmitted using Web Services, according to the requirements specified in Appendix V.

1825 The following WSDL naming conventions SHALL apply:

accept acknowledgment -> "MCCI\_IN000002UV01\_Message"

The following WSDL snippet describes the type for this message:

1830

```

...
<types>
<xsd:schema elementFormDefault="qualified" targetNamespace="urn:h17-org:v3"
xmlns:h17="urn:h17-org:v3">
```

```

1835 <!-- Include the message schema -->
      <xsd:import namespace="urn:hl7-org:v3"
      schemaLocation="../../../schema/HL7V3/NE2008/multicacheschemas/MCCI_IN000002UV01.xsd"/>
      <xsd:element name="MCCI_IN000002UV01"/>
      </xsd:schema>
      </types>
1840 ...
      The message is described by the following snippet:
      ...
      <message name="MCCI_IN000002UV01_Message">
1845 <part element="hl7:MCCI_IN000002UV01" name="Body"/>
      </message>
      ...

```

Various WSDL examples describing IHE transactions as web services are found in the transaction definitions in ITI TF-2a and 2b, together with the expected actions of the actors which provide these services.

### 1850 **O.1.3 Send Application Acknowledgement Information Model (MCCI\_RM000300IHE)**

Below is the Message Information Model for the application acknowledgment. The purpose of the model is to describe the data elements relevant for use with IHE transactions based on HL7 V3 messages. It is a strict subset of the Send Application Acknowledgement (MCCI\_RM000300UV01) RMIM, which can be found on the HL7 V3 2008 Edition CD at: Edition2008/domains/uvci/editable/MCCI\_RM000300UV.htm

The following restrictions were made on the original RMIM to arrive at the restricted model:

- The following optional class attributes have been omitted:
  - Message.profileId
  - 1860 ○ Message.attachmentText
  - Sender.telecom
  - Receiver.telecom
  - Device.desc
  - Device.existenceTime
  - 1865 ○ Acknowledgement.messageWaitingNumber
  - Acknowledgement.messageWaitingPriorityCode
- The following optional classes have been omitted:
  - AttentionLine
  - RespondTo
  - 1870 ○ LocatedEntity

- scopedRole(Organization)
- The following constraints have been applied:
  - Message.acceptAckCode is fixed to NE (don't ack an ack)
  - Acknowledgment is a required class

1875

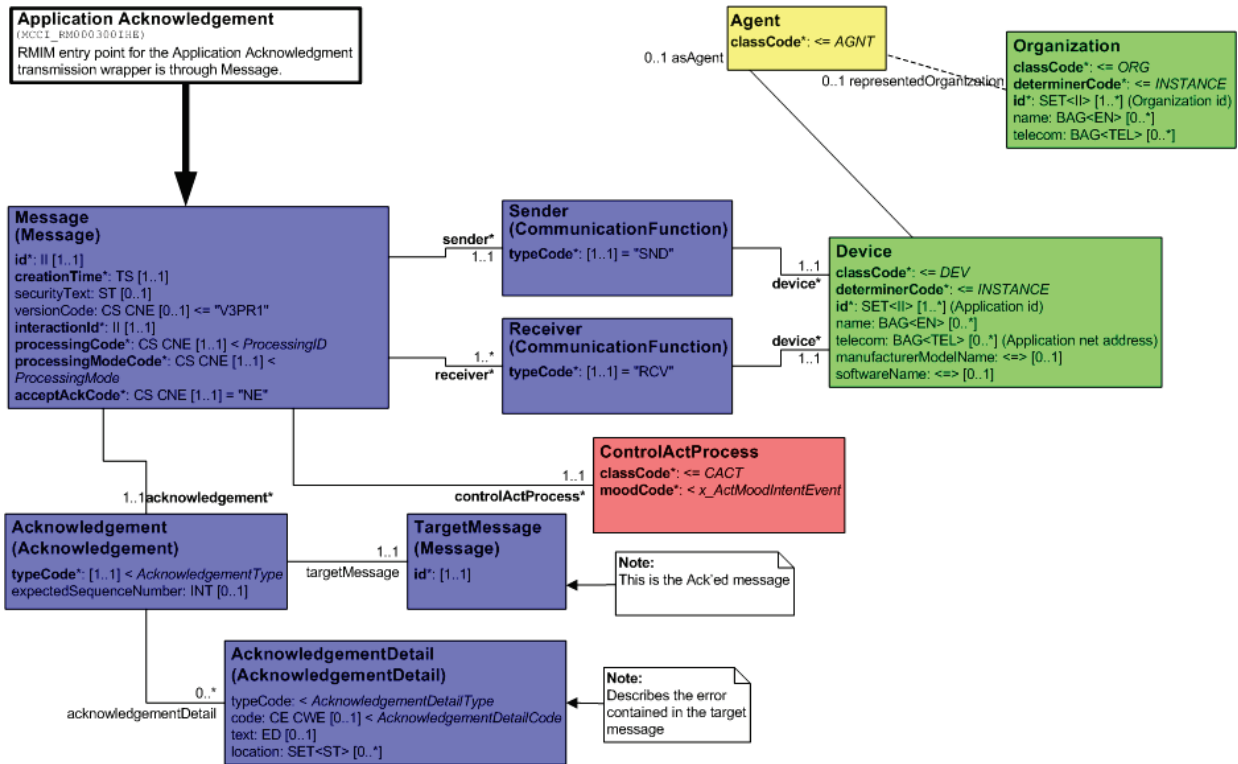

Figure O.1.3-1: Message Information Model

The attributes of this model are described in the following table:

Table O.1.3-1: Model Attributes

MCCI_HD000300IHE Send Application Acknowledgement	This HMD extract defines the transmission wrapper used to send HL7 V3 Application Acknowledgement. Derived from Figure O.1.3-1 (MCCI_RM000300IHE)
<b>Message</b>	The transmission focal class. According of the XML ITS, the root XML element representing this class will be the HL7 interaction ID
id [1..1] (M) Transmission (II)	Unique message ID of the acknowledgment
createTime [1..1] (M) Transmission (TS)	Time stamp representing the time the message was created. Note that this is different from the time when the event which triggered the message occurred.
versionCode [0..1] Message (CS) {CNE:HL7StandardVersionCode, default= "V3PR1"}	The HL7 Version used in this message

<b>MCCI_HD000300IHE Send Application Acknowledgement</b>	<b>This HMD extract defines the transmission wrapper used to send HL7 V3 Application Acknowledgement. Derived from Figure O.1.3-1 (MCCI_RM000300IHE)</b>
interactionId [1..1] (M) Message (II)	The HL7 Interaction ID represented by this message
processingCode [1..1] (M) Message (CS) {CNE:ProcessingID}	This attribute defines whether the message is part of a production, training, or debugging system. Valid values are D (Debugging), T (Testing), P (Production) – see <a href="http://hl7.org/v3ballot2007may/html/infrastructure/vocabulary/ProcessingID.htm">http://hl7.org/v3ballot2007may/html/infrastructure/vocabulary/ProcessingID.htm</a>
processingModeCode [1..1] (M) Message (CS) {CNE:ProcessingMode}	This attribute defines whether the message is being sent in current processing, archive mode, initial load mode, restore from archive mode, etc. Valid values are A (Archive), T (Current processing), I (Initial Load), R (Restore from archive) – see <a href="http://hl7.org/v3ballot2007may/html/infrastructure/vocabulary/ProcessingMode.htm">http://hl7.org/v3ballot2007may/html/infrastructure/vocabulary/ProcessingMode.htm</a>
acceptAckCode [1..1] (M) Message (CS) {CNE:AcknowledgementCondition, fixed="NE"}	Acknowledgement Condition codes describe the conditions under which accept or application level acknowledgements are required to be returned in response to the message send operation. Fixed to NE (Never) as this is an acknowledgment itself.
<b>Sender</b>	The sender is the one which is acknowledging the receipt of a message
typeCode [1..1] (M) CommunicationFunction (CS) {CNE:SND, fixed value= "SND"}	Structural attribute; this is a "Sender" communication function
<b>Receiver</b>	The receiver in the one which sent the message being acknowledged
typeCode [1..1] (M) CommunicationFunction (CS) {CNE:RCV, fixed value= "RCV"}	Structural attribute; this is a "Receiver" communication function
<b>Device</b>	
classCode [1..1] (M) Entity (CS) {CNE:DEV, default= "DEV"}	Structural attribute; this entity is a "Device"
determinerCode [1..1] (M) Entity (CS) {CNE:INSTANCE, fixed value= "INSTANCE"}	Structural attribute; this is a specific device
id [1..*] (M) Entity (SET<II>)	The application ID(s). IHE restriction: id.root SHALL be an ISO OID, and id.extension SHALL NOT have a value.
name [0..*] Entity (BAG<EN>)	Optional Sender or Receiver name
telecom [0..*] Entity (BAG<TEL>)	Optional network address of the application
manufacturerModelName [0..1] Device (SC)	Optional application brand name
softwareName [0..1] Device (SC)	Optional software name
<b>Agent</b>	This role links the application with the organization to which it belongs
classCode [1..1] (M) Role (CS) {CNE:AGNT, default= "AGNT"}	Structural attribute; this is the Agent role
<b>Organization</b>	The sender or receiver organization
classCode [1..1] (M) Entity (CS) {CNE:ORG, default= "ORG"}	Structural attribute; this entity is an organization

<b>MCCI_HD000300IHE Send Application Acknowledgement</b>	<b>This HMD extract defines the transmission wrapper used to send HL7 V3 Application Acknowledgement. Derived from Figure O.1.3-1 (MCCI_RM000300IHE)</b>
determinerCode [1..1] (M) Entity (CS) {CNE:INSTANCE, fixed value= "INSTANCE"}	Structural attribute; this is a specific organization
id [1..*] (M) Entity (SET<II>)	The organization ID(s). IHE restriction: id.root SHALL be an ISO OID, and id.extension SHALL NOT have a value.
name [0..*] Entity (BAG<EN>)	Optional organization name
telecom [0..*] Entity (BAG<TEL>)	Optional telecommunications address
<b>Acknowledgement</b>	
typeCode [1..1] (M) Acknowledgement (CS) {CNE:AcknowledgementType}	The acknowledgement type. Since this is an Accept Acknowledgement, the possible values are CA (Accept Acknowledgement Commit Accept), CE (Accept Acknowledgement Commit Error), or CR (Accept Acknowledgement Commit Reject).
expectedSequenceNumber [0..1] Acknowledgement (INT)	
<b>TargetMessage</b>	The message being acknowledged
id [1..1] (M) Transmission (II)	Unique message ID of the message being acknowledged
<b>AcknowledgementDetail</b>	Describes the error(s) contained in the target message
typeCode [0..1] AcknowledgementDetail (CS) {CNE:AcknowledgementDetailType}	Optional detail type indicating if the problem was an error (E), a warning (W), or informational (I).
code [0..1] AcknowledgementDetail (CE) {CWE:AcknowledgementDetailCode}	An optional coded value, representing the acknowledgement detail being transmitted.
text [0..1] AcknowledgementDetail (ED)	Optional description of the acknowledgement detail being transmitted
location [0..*] AcknowledgementDetail (SET<ST>)	The location within the message where the problem occurred. It is recommended that this is represented via an XPath expression.
<b>ControlActProcess</b>	The transmission content sent as part of the application acknowledgement.

1880

## O.2 HL7 V3 Transmission Content

The HL7 Transmission Content is comprised of 2 parts:

1. A "Trigger Event Control Act" (required for all messages except accept-level acknowledgements, for which it is not permitted)
- 1885 2. The "HL7 Domain Content" specified by an HL7 domain specific technical committee (required for each Trigger Event Control Act)

The "Trigger Event Control Act" contains administrative information related to the "controlled act" which is being communicated as a messaging interaction. It is also the part of HL7 messages that can convey status or commands for logical operations being coordinated between healthcare

1890 applications, e.g., the coordination of query specification/query response interactions and registry act interactions.

Note: The Trigger Event Control Act loosely equates to the EVN segment in HL7 v2.5.

1895 The "HL7 Domain Content" is the primary domain content of the messaging interaction (when it is present). It contains domain specific content that is specified by an HL7 technical committee to satisfy a use case driven requirement for an HL7 messaging interaction. If an interaction contains HL7 Domain Content, then it also contains a Trigger Event Control Act.

For the Refined Message Information Models, Hierarchical Message Definitions and Message Type Table Views, refer to the HL7 V3 2008 Edition CD at:

1900 [Edition2008/domains/uvai/uvai\\_TriggerEventControlAct.htm](#) and  
[Edition2008/domains/uvmi/uvmi\\_MasterFile-Registry.htm](#)

### **O.2.1 Master File/Registry Event Notification Control Act (Role Subject) Information Model (MFMI\_MT700701IHE)**

1905 Below is the Message Information Model for this control act wrapper. The purpose of the model is to describe the data elements relevant for use with IHE transactions based on HL7 V3 messages. It is a strict subset of the Master File / Registry Event Notification (MFMI\_RM700700UV01) RMIM, which can be found on the HL7 V3 2008 Edition CD at: [Edition2008/domains/uvmi/editable/MFMI\\_RM700700UV.htm](#)

The following restrictions were made on the original RMIM to arrive at the restricted model:

- The following optional class attributes have been omitted:
  - 1910 ○ ControlActProcess.text
  - ControlActProcess.priorityCode
  - ControlActProcess.reasonCode
- All participations related to the ControlActProcess have been omitted
- The following act relationships to the RegistrationEvent have been omitted:
  - 1915 ○ inFulfillmentOf
  - definition
  - subject2

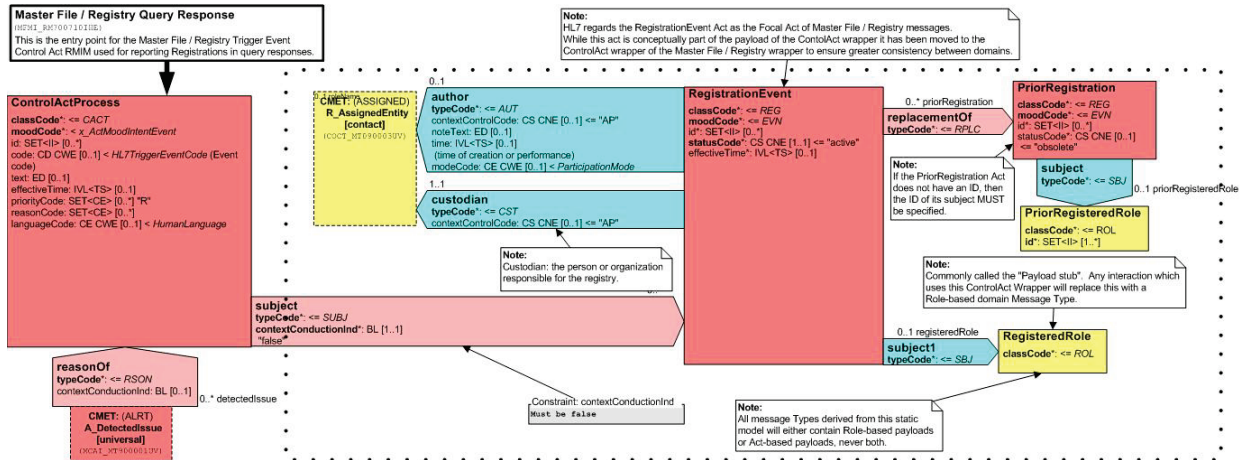

Figure O.2.1-1: Message Information Model

1920

The attributes of this model are described in the following table.

Table O.2.1-1: Model Attributes

MFMI_HD700701IHE Master File / Registry Event Notification (Role Subject)	This HMD extract defines the control act wrapper used to send HL7 V3 master file or registry messages with the subject being a role. Derived from Figure O.2.1-1 (MFMI_RM700701IHE)
<b>Control Act Process</b>	The entry point from the transmission wrapper
classCode [1..1] (M) Act (CS) {CNE:CACT, default="CACT"}	Structural attribute; this is a Control Act
moodCode [1..1] (M) Act (CS) {CNE:x_ActMoodIntentEvent}	Structural attribute; possible values are INT (intent), RQO (request), EVN (event, occurrence), PRP (proposal), RMD (recommendation), APT (appointment), ARQ (appointment request), or PRMS (promise).
id [0..*] Act (SET<II>)	Optional Control Act ID
code [0..1] Act (CD) {CWE:HL7TriggerEventCode}	The HL7 Trigger Event code
effectiveTime [0..1] Act (IVL<TS>)	Optional time stamp or time interval indication when the ControlActProcess took place
languageCode [0..1] Act (CE) {CWE:HumanLanguage}	Optional language code
<b>reasonOf</b>	Act relationship linking the ControlActProcess to a detected issue
typeCode [1..1] (M) ActRelationship (CS) {CNE:V:ActRelationshipReason, root="RSON"}	Structural attribute; this act relationship is "ReasonOf"
contextConductionInd [0..1] ActRelationship (BL)	The context conduction Indicator value in this control act wrapper
detectedIssueEvent [1..1] (A_DetectedIssueDeprecated)	The detected issue related to this event
<b>subject</b>	Act relationship linking the ControlActProcess to the Registration event



<b>MFMI_HD700701IHE Master File / Registry Event Notification (Role Subject)</b>	<b>This HMD extract defines the control act wrapper used to send HL7 V3 master file or registry messages with the subject being a role. Derived from Figure O.2.1-1 (MFMI_RM700701IHE)</b>
typeCode [1..1] (M) ActRelationship (CS) {CNE:SUBJ, fixed value= "SUBJ"}	Structural attribute; this act relationship is "Subject"
contextConductionInd [1..1] (M) ActRelationship (BL){default= "false"}	The context conduction Indicator value in this control act wrapper SHALL be 'false'
<b>RegistrationEvent</b>	Although this part of the model has been included in a specialization of the Trigger Event Control Act wrapper for reasons of consistency, it is conceptually part of the payload of a HL7 interaction. The Focal Act of all interactions that use this model is the RegistrationEvent act, not the subject Role.
classCode [1..1] (M) Act (CS) {CNE:REG, fixed value= "REG"}	Structural attribute; this act is a registration
moodCode [1..1] (M) Act (CS) {CNE:EVN, fixed value= "EVN"}	Structural attribute; this is an occurrence of the act
id [0..*] Act (SET<II>)	Optional registration event identifier(s).
statusCode [1..1] (M) Act (CS) {CNE:ActStatus, default= "active"}	The status of the registration event. The default is "active".
effectiveTime [0..1] Act (IVL<TS>)	Optional time stamp or interval indicating when the registration event took place. IHE constraint: if this attribute is valued, the author.time SHALL be valued with the same time expression.
<b>subject</b>	The participation linking the Registration Event to the payload focal role (usually Patient).
typeCode [1..1] (M) Participation (CS) {CNE:SBJ, default= "SBJ"}	Structural attribute; this is a "subject" participation
<b>RegisteredRole</b>	The payload stub. Replaced by a role-based payload from the domain content
<b>author</b>	This participation represents the entity which authored the registration. The Assigned Entity SHOULD be a person, MAY be a device or an organization, and SHALL NOT be a non-person living subject.
typeCode [1..1] (M) Participation (CS) {CNE:AUT, fixed value= "AUT"}	Structural attribute; this participation is of type "Author"
contextControlCode [0..1] Participation (CS) {CNE:ContextControl, default= "AP"}	Optional contextControlCode, the default is "AP"
time [0..1] Participation (IVL<TS>)	Time of creation or performance. IHE constraint: If this attribute is valued, the RegistrationEvent.effectiveTime SHALL be valued with the same time expression
modeCode [0..1] Participation (CE) {CWE:ParticipationMode}	This is the optional participation mode
<b>custodian</b>	The application or organization responsible for the patient identity source. This participation is required. IHE restriction: the assigned entity SHALL be either an organization or a device.
typeCode [1..1] (M) Participation (CS) {CNE:CST, fixed value= "CST"}	Structural attribute; this participation id of type "Custodian"

<b>MFMI_HD700701IHE Master File / Registry Event Notification (Role Subject)</b>	<b>This HMD extract defines the control act wrapper used to send HL7 V3 master file or registry messages with the subject being a role. Derived from Figure O.2.1-1 (MFMI_RM700701IHE)</b>
contextControlCode [0..1] Participation (CS) {CNE:ContextControl, default= "AP"}	Optional contextControlCode, the default is "AP"
<b>ReplacementOf</b>	The relationship between the current Registration Event and other registration events which are being replaced by the current one.
typeCode [1..1] (M) ActRelationship (CS) {CNE:RPLC, fixed value= "RPLC"}	Structural attribute; this is a "Replace" relationship
<b>PriorRegistration</b>	The previous registration event, which is being replaced by the current one. An example is the Resolve Duplicates message, where the prior registration contains the subject role with the identifiers which have been merged into the role of the current registration event.
classCode [1..1] (M) Act (CS) {CNE:REG, fixed value= "REG"}	Structural attribute; this act is a registration
moodCode [1..1] (M) Act (CS) {CNE:EVN, fixed value= "EVN"}	Structural attribute; this is an occurrence of the act
id [0..*] Act (SET<II>)	Optional prior registration event identifier(s).
statusCode [1..1] (M) Act (CS) {CNE:ActStatus, default= "obsolete"}	The status of the registration event. The default is "obsolete".
<b>PriorRegisteredRole</b>	The role subject of the prior registration.
classCode [1..1] (M) Act (CS) {CNE:ROL, fixed value= "ROL"}	Structural attribute; this class is a role
id [1..*] (M) Role (SET<II>)	Identifiers of the role subject of the prior registration. Usually contains the merged ID of a patient after duplicate resolution.

## O.2.2 Master File/Registry Query Response Control Act (Role Subject) Information Model (MFMI\_MT700711IHE)

1925

Below is the Message Information Model for this control act wrapper. The purpose of the model is to describe the data elements relevant for use with IHE transactions based on HL7 V3 messages. It is a strict subset of the Master File / Registry Query Response (MFMI\_RM700710UV01) RMIM, which can be found on the HL7 V3 2008 Edition CD at: Edition2008/domains/uvmi/editable/MFMI\_RM700710UV.htm. The following restrictions were made on the original RMIM to arrive at the restricted model:

1930

- The following optional class attributes have been omitted:
  - ControlActProcess.text
  - ControlActProcess.priorityCode
  - ControlActProcess.reasonCode

1935

- All participations related to the ControlActProcess have been omitted
- The reasonOf act relationship has been omitted
- The following act relationships to the RegistrationEvent have been omitted:
  - inFulfillmentOf
  - definition
  - subject2

1940

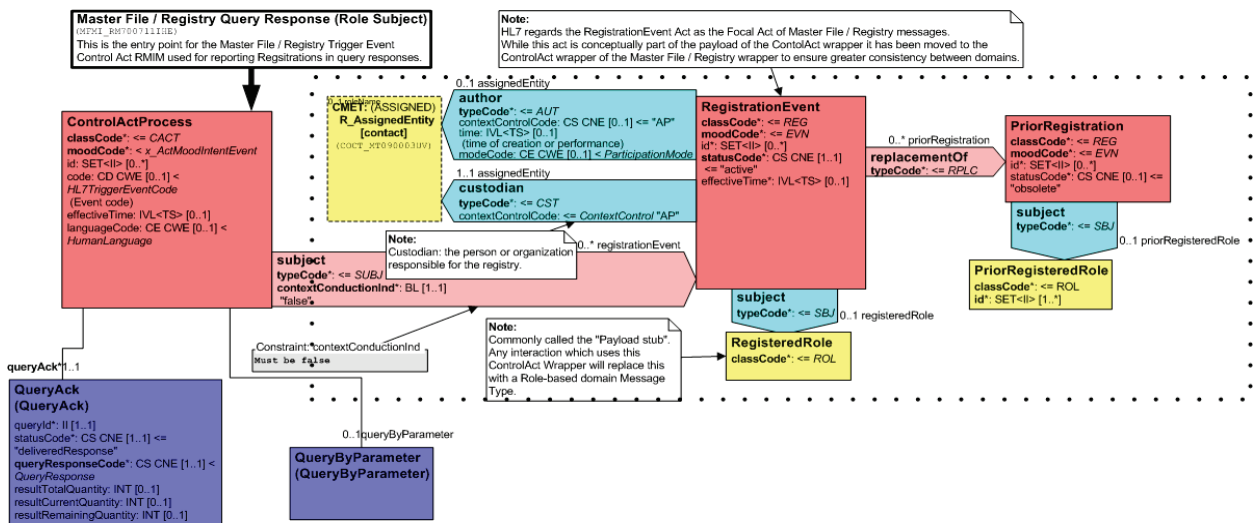

Figure O.2.2-1: Message Information Model

1945 The attributes of this model are described in the following table.

Table O.2.2-1: Model Attributes

MFMI_HD700711IHE Master File / Registry Event Notification (Role Subject)	This HMD extract defines the control act wrapper used to send HL7 V3 master file or registry query responses with the subject being a role. Derived from Figure O.2.2-1 (MFMI_RM700711IHE)
<b>Control Act Process</b>	The entry point from the transmission wrapper
classCode [1..1] (M) Act (CS) {CNE:CACT, default="CACT"}	Structural attribute; this is a Control Act
moodCode [1..1] (M) Act (CS) {CNE:x_ActMoodIntentEvent}	Structural attribute; possible values are INT (intent), RQO (request), EVN (event, occurrence), PRP (proposal), RMD (recommendation), APT (appointment), ARQ (appointment request), or PRMS (promise).
id [0..*] Act (SET<II>)	Optional Control Act ID
code [0..1] Act (CD) {CWE:HL7TriggerEventCode}	The HL7 Trigger Event code
effectiveTime [0..1] Act (IVL<TS>)	Optional time stamp or time interval indication when the ControlActProcess took place

<b>MFMI_HD700711IHE Master File / Registry Event Notification (Role Subject)</b>	<b>This HMD extract defines the control act wrapper used to send HL7 V3 master file or registry query responses with the subject being a role. Derived from Figure O.2.2-1 (MFMI_RM700711IHE)</b>
languageCode [0..1] Act (CE) {CWE:HumanLanguage}	Optional language code
<b>subject</b>	Act relationship linking the ControlActProcess to the Registration event. Note that in the event of a query for which there are no results, the ControlActProcess will still be returned, but no RegistrationEvent will be present.
typeCode [1..1] (M) ActRelationship (CS) {CNE:SUBJ, fixed value= "SUBJ"}	Structural attribute; this act relationship is "Subject"
contextConductionInd [1..1] (M) ActRelationship (BL){default= "false"}	The context conduction Indicator value in this control act wrapper SHALL be 'false'
<b>RegistrationEvent</b>	Although this part of the model has been included in a specialization of the Trigger Event Control Act wrapper for reasons of consistency, it is conceptually part of the payload of a HL7 interaction. The Focal Act of all interactions that use this model is the RegistrationEvent act, not the subject Role. In cases where a query response has no records to return, there will be no RegistrationEvent being returned.
classCode [1..1] (M) Act (CS) {CNE:REG, fixed value= "REG"}	Structural attribute; this act is a registration
moodCode [1..1] (M) Act (CS) {CNE:EVN, fixed value= "EVN"}	Structural attribute; this is an occurrence of the act
id [0..*] Act (SET<II>)	Optional registration event identifier(s).
statusCode [1..1] (M) Act (CS) {CNE:ActStatus, default= "active"}	The status of the registration event. The default is "active".
effectiveTime [0..1] Act (IVL<TS>)	Optional time stamp or interval indicating when the registration event took place. IHE constraint: if this attribute is valued, the author.time SHALL be valued with the same time expression.
<b>subject</b>	The participation linking the Registration Event to the payload focal role (usually Patient).
typeCode [1..1] (M) Participation (CS) {CNE:SBJ, default= "SBJ"}	Structural attribute; this is a "subject" participation
<b>RegisteredRole</b>	The payload stub. Replaced by a role-based payload from the domain content
<b>author</b>	This participation represents the entity which authored the registration. The Assigned Entity SHOULD be a person, MAY be a device or an organization, and SHALL NOT be a non-person living subject.
typeCode [1..1] (M) Participation (CS) {CNE:AUT, fixed value= "AUT"}	Structural attribute; this participation is of type "Author"
contextControlCode [0..1] Participation (CS) {CNE:ContextControl, default= "AP"}	Optional contextControlCode, the default is "AP"
time [0..1] Participation (IVL<TS>)	Time of creation or performance. IHE constraint: If this attribute is valued, the RegistrationEvent.effectiveTime SHALL be valued with the same time expression
modeCode [0..1] Participation (CE) {CWE:ParticipationMode}	This is the optional participation mode

<b>MFMI_HD700711IHE Master File / Registry Event Notification (Role Subject)</b>	<b>This HMD extract defines the control act wrapper used to send HL7 V3 master file or registry query responses with the subject being a role. Derived from Figure O.2.2-1 (MFMI_RM700711IHE)</b>
<b>custodian</b>	The application or organization responsible for the patient identity source. This participation is required. IHE restriction: the assigned entity SHALL be either an organization or a device.
typeCode [1..1] (M) Participation (CS) {CNE:CST, fixed value="CST"}	Structural attribute; this participation id of type "Custodian"
contextControlCode [0..1] Participation (CS) {CNE:ContextControl, default="AP"}	Optional contextControlCode, the default is "AP"
ReplacementOf	The relationship between the current Registration Event and other registration events which are being replaced by the current one.
typeCode [1..1] (M) ActRelationship (CS) {CNE:RPLC, fixed value="RPLC"}	Structural attribute; this is a "Replace" relationship
<b>PriorRegistration</b>	The previous registration event, which is being replaced by the current one. An example is the Resolve Duplicates message, where the prior registration contains the subject role with the identifiers which have been merged into the role of the current registration event.
classCode [1..1] (M) Act (CS) {CNE:REG, fixed value="REG"}	Structural attribute; this act is a registration
moodCode [1..1] (M) Act (CS) {CNE:EVN, fixed value="EVN"}	Structural attribute; this is an occurrence of the act
id [0..*] Act (SET<II>)	Optional prior registration event identifier(s).
statusCode [1..1] (M) Act (CS) {CNE:ActStatus, default="obsolete"}	The status of the registration event. The default is "obsolete".
<b>PriorRegisteredRole</b>	The role subject of the prior registration.
classCode [1..1] (M) Act (CS) {CNE:ROL, fixed value="ROL"}	Structural attribute; this class is a role
id [1..*] (M) Role (SET<II>)	Identifiers of the role subject of the prior registration. Usually contains the merged ID of a patient after duplicate resolution.
<b>QueryAck</b>	Information about the query to which this message is a response
queryId [1..1] (R) QueryEvent (II)	The query ID to which this message is a response.
statusCode [1..1] (R) QueryEvent (CS) {CNE:QueryStatusCode, default="deliveredResponse"}	The status of the query event. The default is "deliveredResponse". Possible values are "aborted", "executing", "new", "waitContinuedQueryResponse"
queryResponseCode [1..1] (M) QueryAck (CS) {CNE:QueryResponse}	Code representing the content of the response. Possible values are AE (application error), OK (data found), NF (no data found), QE (query parameter error).
resultTotalQuantity [0..1] QueryAck (INT)	Total number of results found.
resultCurrentQuantity [0..1] QueryAck (INT)	The number of results in this message.

<p><b>MFMI_HD700711IHE Master File / Registry Event Notification (Role Subject)</b></p>	<p><b>This HMD extract defines the control act wrapper used to send HL7 V3 master file or registry query responses with the subject being a role. Derived from Figure O.2.2-1 (MFMI_RM700711IHE)</b></p>
<p>resultRemainingQuantity [0..1] QueryAck (INT)</p>	<p>The number of results not transmitted yet.</p>
<p>queryByParameter</p>	<p>The stub to an optional copy of the Query By Parameter payload of the original query.</p>

### **O.2.3 Query Control Act Request: Query By Parameter Information Model (QUQI\_MT021001IHE)**

1950 Below is the Message Information Model for this control act wrapper. The purpose of the model is to describe the data elements relevant for use with IHE transactions based on HL7 V3 messages. It is a strict subset of the Query Specification Control Act: Query By Parameter (QUQI\_RM021000UV01) RMIM, which can be found on the HL7 V3 2008 Edition CD at: Edition2008/domains/uvqi/editable/QUQI\_RM021000UV.htm. The following restrictions were  
1955 made on the original RMIM to arrive at the restricted model:

- The following optional class attributes have been omitted:
  - ControlActProcess.text
  - ControlActProcess.priorityCode
  - ControlActProcess.reasonCode

- 1960
- The following participations related to the ControlActProcess have been omitted:
    - overseer
    - dataEnterer
    - informationRecipient
  - The reasonOf act relationship has been omitted

1965

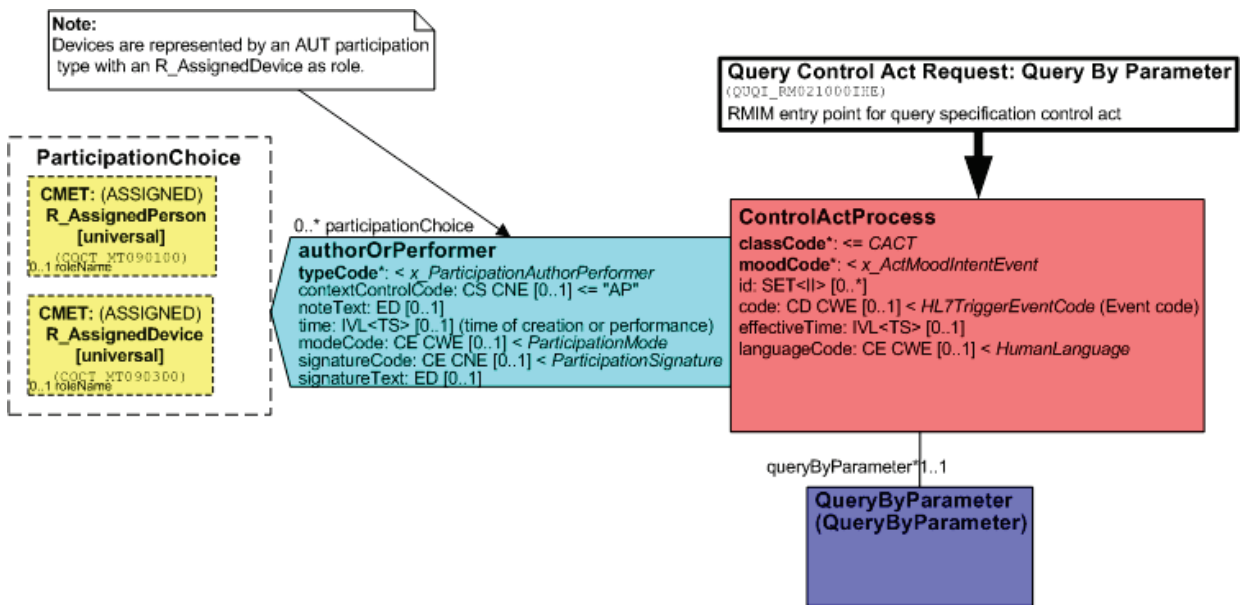

Figure O.2.3-1: Message Information Model

The attributes of this model are described in the following table.

Table O.2.3-1: Model Attributes

QUQI_HD021000IHE Query Control Act Request: QueryByParameter	This HMD extract defines the control act wrapper used to send HL7 V3 query by parameter messages. Derived from Figure O.2.3-1 (QUQI_RM021000IHE)
<b>Control Act Process</b>	The entry point from the transmission wrapper
classCode [1..1] (M) Act (CS) {CNE:CACT, default="CACT"}	Structural attribute; this is a Control Act
moodCode [1..1] (M) Act (CS) {CNE:x_ActMoodIntentEvent}	Structural attribute; possible values are INT (intent), RQO (request), EVN (event, occurrence), PRP (proposal), RMD (recommendation), APT (appointment), ARQ (appointment request), or PRMS (promise).
id [0..*] Act (SET<II>)	Optional Control Act ID
code [0..1] Act (CD) {CWE:HL7TriggerEventCode}	The HL7 Trigger Event code
effectiveTime [0..1] Act (IVL<TS>)	Optional time stamp or time interval indication when the ControlActProcess took place
languageCode [0..1] Act (CE) {CWE:HumanLanguage}	Optional language code
<b>authorOrPerformer</b>	This optional participation represents the entity which made the query. The author of the query SHOULD be a person, or it MAY be a device.
typeCode [1..1] (M) Participation (CS) {CNE:x_ParticipationAuthorPerformer}	Structural attribute; this participation is of type "AUT" or "PRF"

<b>QUQI_HD021000IHE Query Control Act Request: QueryByParameter</b>	<b>This HMD extract defines the control act wrapper used to send HL7 V3 query by parameter messages. Derived from Figure O.2.3-1 (QUQI_RM021000IHE)</b>
contextControlCode [0..1] Participation (CS) {CNE:ContextControl, default= "AP"}	Optional contextControlCode, the default is "AP"
time [0..1] Participation (IVL<TS>)	Time of creation or performance.
modeCode [0..1] Participation (CE) {CWE:ParticipationMode}	This is the optional participation mode
<b>queryByParameter</b>	The stub to the Query By Parameter payload.

1970

### O.2.4 Query Control Act Request Continue/Cancel Information Model (QUQI\_MT000001IHE)

1975

Below is the Message Information Model for this control act wrapper. The purpose of the model is to describe the data elements relevant for use with IHE transactions based on HL7 V3 messages. It is a strict subset of the Query Continuation/Cancel Control Act (QUQI\_RM000001UV01) RMIM, which can be found on the HL7 V3 2008 Edition CD at: Edition2008/domains/uvqi/editable/QUQI\_RM000001UV.htm

The following restrictions were made on the original RMIM to arrive at the restricted model:

1980

- The following optional class attributes have been omitted:
  - ControlActProcess.text
  - ControlActProcess.priorityCode
  - ControlActProcess.reasonCode
- All participations related to the ControlActProcess have been omitted
- The reasonOf act relationship has been omitted
- ControlActProcess.moodCode is fixed to EVN
- QueryContinuation.queryId is Mandatory
- QueryContinuation.statusCode is defaulted to "waitContinuedQueryResponse"

1985



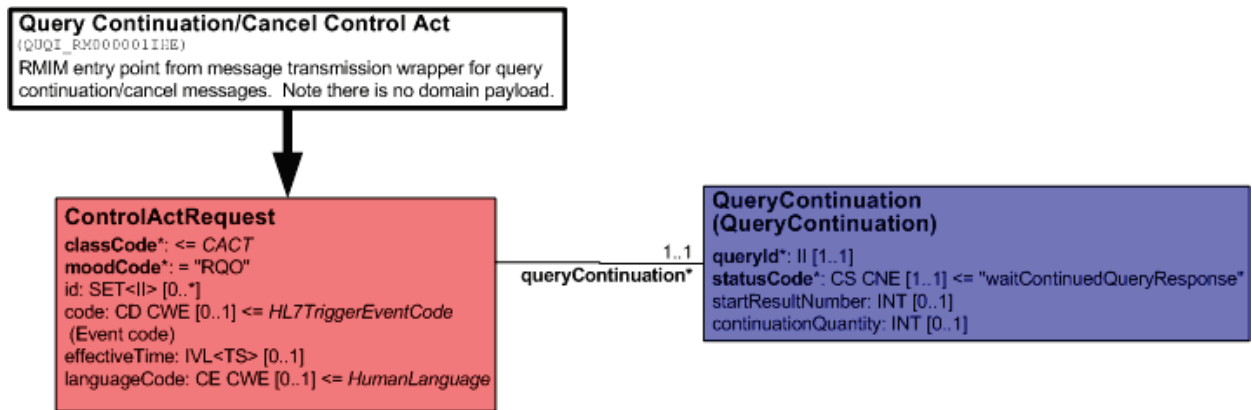

1990

Figure O.2.4-1: Message Information Model

The attributes of this model are described in the following table.

Table O.2.4-1: Model Attributes

QUQI_HD000001IHE Query Control Act Request Continuation/Cancel Control Act	This HMD extract defines the control act of the query continuation request. Note that there is no payload. Derived from Figure O.2.4-1 (QUQI_RM021000IHE)
<b>Control Act Process</b>	The entry point from the transmission wrapper
classCode [1..1] (M) Act (CS) {CNE:CACT, default="CACT"}	Structural attribute; this is a Control Act
moodCode [1..1] (M) Act (CS) {CNE:x_ActMoodIntentEvent, fixed="EVN"}	This is a request
id [0..*] Act (SET<II>)	Optional Control Act ID
code [0..1] Act (CD) {CWE:HL7TriggerEventCode}	The HL7 Trigger Event code
effectiveTime [0..1] Act (IVL<TS>)	Optional time stamp or time interval indication when the ControlActProcess took place
languageCode [0..1] Act (CE) {CWE:HumanLanguage}	Optional language code
<b>QueryContinuation</b>	The information about the query, which is being continued
queryId [1..1](M) QueryEvent (II)	The query identifier, which links this continuation request with the original query.
statusCode [1..1] (M) QueryEvent (CS) {CNE:QueryStatusCode, default="waitContinuedQueryResponse"}	The query status. The only other possible value is "aborted", indicating that no more results are needed from the query fulfiller.
startResultNumber [0..1] QueryContinuation (INT)	Optionally, the query placer may request that the list of responses starts from a particular unit (based on the total number of responses returned by the query fulfiller to the original query)
continuationQuantity [0..1] QueryContinuation (INT)	Optionally, the query placer may specify the maximum number of responses to be returned by the query fulfiller. If 0 is specified, this is an indication that the query is cancelled. If this attributed is not valued, the query fulfiller shall use the quantity specified in the most recent query or continuation request.

### O.3 IHE Transactions and Corresponding Transmission and Control Act Wrappers

1995 The following table lists the wrappers for the currently defined IHE transactions, which use HL7 V3 messages.

**Table O.3-1: IHE Transactions and Corresponding Transmission and Control Act Wrappers**

Transaction Reference	Transmission Wrapper	Control Act Wrapper
3.44.4 – Patient Add or Revise	MCCI_MT000100UV01	MFMI_MT700701UV01
3.44.4 – Resolve Duplicates	MCCI_MT000100UV01	MFMI_MT700701UV01
3.44.4 – Acknowledgement	MCCI_MT000200UV01	None
3.45.4 – Get Corresponding Identifiers	MCCI_MT000100UV01	QUQI_MT021001UV01
3.45.4 – Get Corresponding Indenters Response	MCCI_MT000300UV01	MFMI_MT700711UV01
3.46.4 – Revise Demographic Data	MCCI_MT000100UV01	MFMI_MT700701UV01
3.46.4 – Acknowledgement	MCCI_MT000200UV01	None
3.47.4 – Find Candidates Query	MCCI_MT000100UV01	QUQI_MT021001UV01
3.47.4 – Find Candidates Response	MCCI_MT000300UV01	MFMI_MT700711UV01
3.47.4 – Query Continuation	MCCI_MT000300UV01	QUQI_MT000001UV01
3.47.4 – Acknowledgement	MCCI_MT000200UV01	None

2000

## Appendix P: Examples of messages

### P.1 Example of Admit for Surgical Procedure, [ITI-31] Transaction

2005 This example illustrates the use of [ITI-31] with the following options:

- Inpatient/Outpatient Encounter Management
- Advanced Encounter Management
- Temporary Patient Transfer Track
- Historic Movement Management

#### 2010 P.1.1 Storyboard

2015 Robert LAW arrives from home to Saint-Louis Hospital. Operator Janine WHITE registers Robert in the administrative systems and creates a new account for billing. The reason of admission is a surgery of the heart, and Robert is under the responsibility of Cardiology. Before the surgery, a chest X-Ray and an electrocardiogram have to be performed. After the surgery, Robert is transferred to the Intensive Care Unit for 2 days. The transfer to the ICU is entered with two errors (wrong bed, wrong time). This transfer is corrected with the appropriate values. Then Robert is transferred back to Cardiology. Two weeks after admission, Robert is sent back home. Later on, his last movement in cardiology is corrected.

**Table P.1.1-1: Storyboard Attribute Values**

Objects	Attributes
Patient	Legal name: Robert LAW ID: 12345 Sex: male Date of birth: October 2 <sup>nd</sup> 1946 Billing Account Number: 987654
Administrative Operator	Legal name: Janine WHITE, ID: 1001 Legal name: Eva STRAW, ID: 1002 Legal name: Betty GARDNER, ID: 1003 Legal name: Jana BLACKMORE, ID: 1004
Assigning Facility	Saint-Louis Hospital
Attending Doctors	Legal name: Charles BROWN, ID: 2001 Legal name: Ray JOHNSON, ID: 2002
Family Doctor	Legal name: Bob FAMILY, ID 7777
Medical Departments	Name: Cardiology, Code: 6043, Bed: 1, Room: 200 Name: Cardiology, Code: 6043, Bed: 3, Room: 202 Name: Radiology, Code: 5001 Name: ICU, Code: 5050, Bed: 1, Room: 430

2020

### **P.1.2 Interaction Diagram**

The following diagram illustrates the interactions used in this example. The acknowledgement messages are not shown.

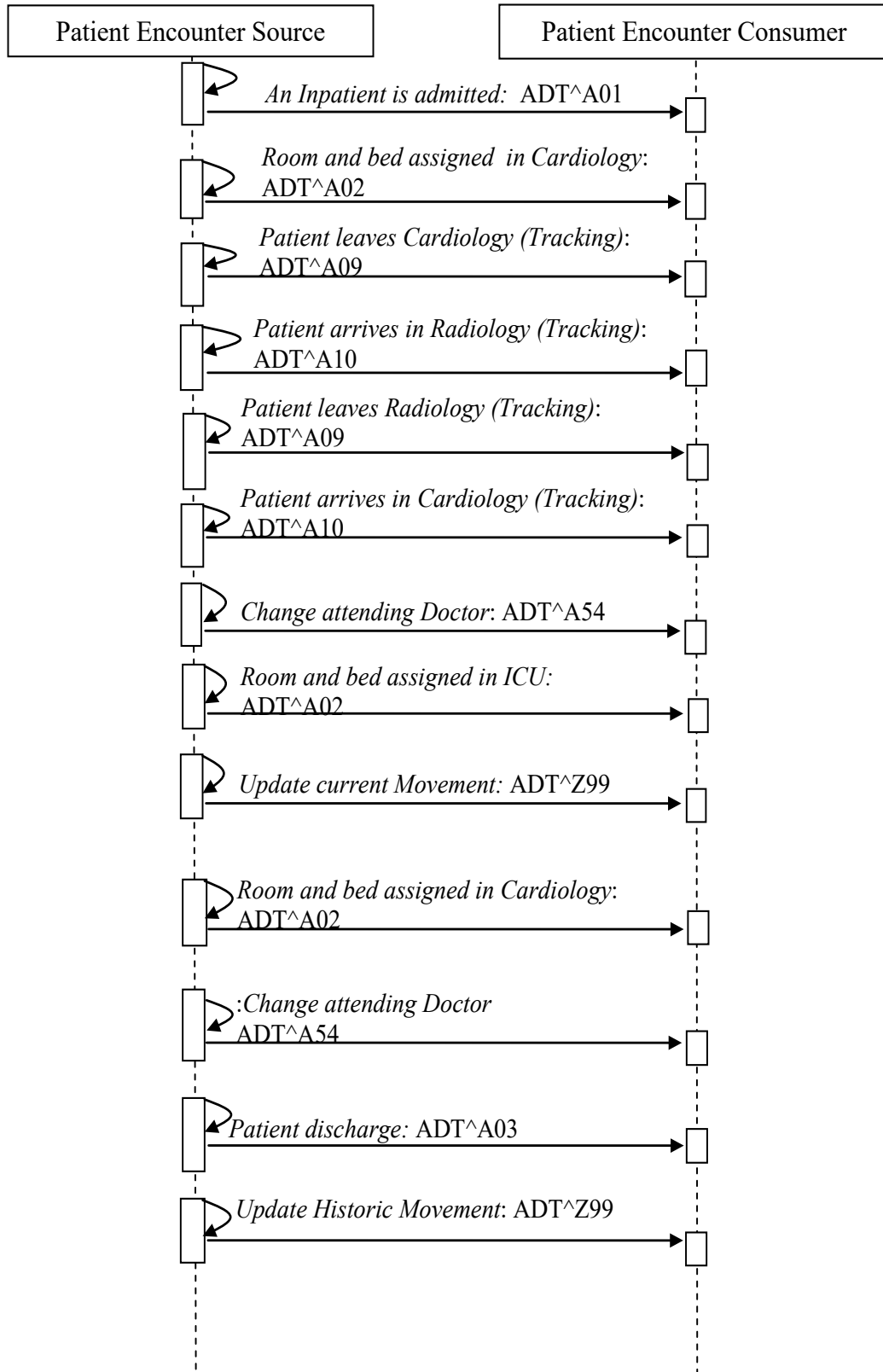

2025 **P.1.3 Messages**

Operator Janine White admits Robert Law as an Inpatient in the administrative system of Saint-Louis Hospital. She creates a new billing account number (987654). The attending doctor of Robert Law is Doctor Charles Brown, during Robert’s stay in the Cardiology department.

```

2030 MSH|^~\&|?|Saint-Louis|?|Saint-
Louis|20050530082015||ADT^A01^ADT_A01|000001|T|2.5|||FRA|8859/15|EN
EVN||20050530082000||1001^WHITE^Janine|20050530082000
PID|1||12345^^^Saint-Louis^PI||LAW^Robert^^^^^L||M|||||
987654^^^Saint-Louis^AN
2035 ROL||AD|FHCP|7777^FAMILY^Bob
PV1|1|I||||2001^BROWN^Charles
ZBE|mvt1|20050530082000||INSERT|N
    
```

Robert LAW arrives in Cardiology and a secretary (Eva STRAW) validates the arrival by assigning a room and a bed to the Patient. Had the bed been assigned at admission time, the patient location would have been part of the ADT^A01 message.

```

2040 MSH|^~\&|?|Saint-Louis|?|Saint-
Louis|20050530082015||ADT^A02^ADT_A02|000001|T|2.5|||FRA|8859/15|EN
EVN||20050530082500||1002^STRAW^Eva|20050530082500
PID|1||12345^^^Saint-Louis^PI||LAW^Robert^^^^^L||M|||||
2045 987654^^^Saint-Louis^AN
PV1|1|I||6043^200^1^Saint-Louis
ZBE|mvt2|20050530082500||INSERT|N
    
```

The electrocardiogram is performed in the Cardiology department. However, Robert needs to be transferred to Radiology for the chest X-Ray. This move to a temporary location is tracked by two messages: A09 when departing the cardiology, A10 when arrived in Radiology. These tracking events are not Movements, and don’t use the ZBE segment.

```

2050 MSH|^~\&|?|Saint-Louis|?|Saint-
Louis|20050530082015||ADT^A09^ADT_A09|000001|T|2.5|||FRA|8859/15|EN
2055 EVN||20050530123000||1002^STRAW^Eva|20050530122500
PID|1||12345^^^Saint-Louis^PI||LAW^Robert^^^^^L||M|||||
987654^^^Saint-Louis^AN
PV1|1|I||||6043^200^1^Saint-Louis||||5001^^^Saint-Louis
    
```

```

2060 MSH|^~\&|?|Saint-Louis|?|Saint-
Louis|20050530082015||ADT^A10^ADT_A09|000001|T|2.5|||FRA|8859/15|EN
EVN||20050530123000||1003^GARDNER^Betty|20050530123000
PID|1||12345^^^Saint-Louis^PI||LAW^Robert^^^^^L||M|||||
2065 987654^^^Saint-Louis^AN
PV1|1|I||||6043^200^1^Saint-Louis||||5001^^^Saint-Louis
    
```

2070 When the X-Ray is performed, Robert leaves the Radiology department and comes back to Cardiology. Two other movement-tracking messages are generated.

```
MSH|^~\&|?|Saint-Louis|?|Saint-
Louis|20050530082015||ADT^A09^ADT_A09|000001|T|2.5|||FRA|8859/15|EN
EVN||20050530123000||1002^STRAW^Eva|20050530125000
2075 PID|1||12345^^^Saint-Louis^PI||LAW^Robert^^^^^L||M|||||
987654^^^Saint-Louis^AN
PV1|1|I|6043^200^1^Saint-Louis|||
|5001^^^Saint-Louis
```

2080  
2085

```
MSH|^~\&|?|Saint-Louis|?|Saint-
Louis|20050530082015||ADT^A10^ADT_A09|000001|T|2.5|||FRA|8859/15|EN
EVN||20050530123000||1002^STRAW^Eva|20050530125000
PID|1||12345^^^Saint-Louis^PI||LAW^Robert^^^^^L||M|||||
987654^^^Saint-Louis^AN
PV1|1|I|6043^200^1^Saint-Louis|||
|5001^^^Saint-Louis
```

The surgery is planned for the next day. When the surgery is completed, Robert LAW is transferred to the Intensive Care Unit for 2 days. Ray JOHNSON is the new attending physician during these 2 days.

2090  
2095

```
MSH|^~\&|?|Saint-Louis|?|Saint-
Louis|20050530082015||ADT^A54^ADT_A54|000001|T|2.5|||FRA|8859/15|EN
EVN||20050531114000||1002^STRAW^Eva|20050531114000
PID|1||12345^^^Saint-Louis^PI||LAW^Robert^^^^^L||M|||||
987654^^^Saint-Louis^AN
2095 PV1|1|I|||||2002^JOHNSON^Ray
ZBE|mvt3|20050531114000||INSERT|N
```

When Robert LAW arrives in ICU, a secretary (Jana BLACKMORE) validates the arrival by assigning a room and a bed. She makes two typing mistakes (wrong bed, wrong time)

2100  
2105

```
MSH|^~\&|?|Saint-Louis|?|Saint-
Louis|20050530082015||ADT^A02^ADT_A02|000001|T|2.5|||FRA|8859/15|EN
EVN||20050531114400||1004^BLACKMORE^Jana|20050531114400
PID|1||12345^^^Saint-Louis^PI||LAW^Robert^^^^^L||M|||||
987654^^^Saint-Louis^AN
2105 PV1|1|I|5050^430^11^Saint-Louis|||6043^200^1^Saint-Louis
ZBE|mvt4|20050531114400||INSERT|N
```

2110

After Robert LAW is moved to his new bed, Jana BLACKMORE corrects the two mistyping in the movement.

2115	MSH ^~\& ? Saint-Louis ? Saint-Louis 20050530082015  ADT^Z99^ADT_A01 000001 T 2.5   FRA 8859/15 EN
	EVN  20050531114400  1004^BLACKMORE^Jana 20050531115800
	PID 1  12345^^^Saint-Louis^PI  LAW^Robert^^^^L  M
	987654^^^Saint-Louis^AN
2120	PV1 1 I 5050^430^1^Saint-Louis  6043^200^1^Saint-Louis
	ZBE mvt4 20050531104400  UPDATE N A02



After 2 days, Robert LAW leaves the ICU and comes back to Cardiology. A new room and bed are assigned to the Patient.

2125 MSH|^~\&|?|Saint-Louis|?|Saint-Louis|20050530082015||ADT^A02^ADT\_A02|000001|T|2.5|||FRA|8859/15|EN  
 EVN||20050601161200||1002^STRAW^Eva|20050601161200  
 PID|1||12345^^^Saint-Louis^PI||LAW^Robert^^^^L||M|||||||  
 987654^^^Saint-Louis^AN  
 2130 PV1|1|I|6043^202^2^Saint-Louis||5050^430^1^Saint-Louis  
 ZBE|mvt5|20050601161200||INSERT|N

2135 MSH|^~\&|?|Saint-Louis|?|Saint-Louis|20050530082015||ADT^A54^ADT\_A54|000001|T|2.5|||FRA|8859/15|EN  
 EVN||20050601161000||1004^BLACKMORE^Jana|20050601161200  
 PID|1||12345^^^Saint-Louis^PI||LAW^Robert^^^^L||M|||||||  
 987654^^^Saint-Louis^AN  
 PV1|1|I||||2001^BROWN^Charles  
 ZBE|mvt6|20050601161200||INSERT|N

2140

After 12 days, Robert LAW is discharged and sent back home.

2145 MSH|^~\&|?|Saint-Louis|?|Saint-Louis|20050530082015||ADT^A03^ADT\_A03|000001|T|2.5|||FRA|8859/15|EN  
 EVN||20050613180000||1001^WHITE^Janine|20050613180000  
 PID|1||12345^^^Saint-Louis^PI||LAW^Robert^^^^L||M|||||||  
 987654^^^Saint-Louis^AN  
 PV1|1|I|6043^200^1^Saint-Louis|||1  
 ZBE|mvt7|20050613180000||INSERT|N

2150 One hour later the Cardiology corrects an error of both time and bed in the last patient assigned location in cardiology, triggering an update of the Historic Movement identified as mvt5:

2155 MSH|^~\&|?|Saint-Louis|?|Saint-Louis|20050530082015||ADT^Z99^ADT\_A01|000001|T|2.5|||FRA|8859/15|EN  
 EVN||20050601161200||1002^STRAW^Eva|20050613190000  
 PID|1||12345^^^Saint-Louis^PI||LAW^Robert^^^^L||M|||||||  
 987654^^^Saint-Louis^AN  
 PV1|1|I|6043^202^3^Saint-Louis||5050^430^1^Saint-Louis  
 ZBE|mvt5|20050601161233||UPDATE|Y|A02

2160 **P.2 Example of Admit and cancel admit, [ITI-31] Transaction**

This example uses transaction [ITI-31] without any option, to illustrate a cancellation message:

**P.2.1 Storyboard**

2165 Operator Janine WHITE registers an admission for patient Robert LAW in the administrative system of Saint-Louis Hospital. After a while it turns out that the patient has been directed to the wrong hospital. The patient is redirected to another hospital and the admission is cancelled.

**Table P.2.1-1: Storyboard Attribute Values**

Objects	Attributes
Patient	Legal name: Robert LAW ID: 12345 Sex: male Date of birth: October 2 <sup>nd</sup> 1946 Billing Account Number: 987654
Administrative Operator	Legal name: Janine WHITE, ID: 1001
Assigning Facility	Saint-Louis Hospital
Attending Doctors	Legal name: Charles BROWN, ID: 2001 Legal name: Ray JOHNSON, ID: 2002
Family Doctor	Legal name: Bob FAMILY, ID 7777

**P.2.2 Interaction Diagram**

2170 The following diagram illustrates the interactions used in this example. The acknowledgement messages are not shown.

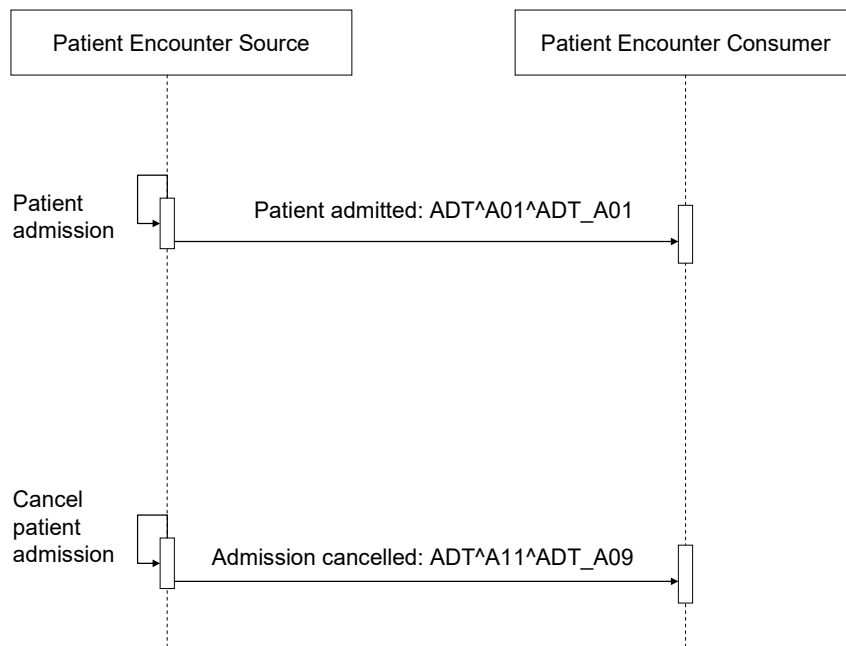

**Figure P.2.2-1: Interaction Diagram**

### P.2.3 Messages

2175 Operator Janine White admits Robert Law as an Inpatient in the administrative system of Saint-Louis Hospital. She creates a new billing account number (987654). The attending doctor of Robert Law is Doctor Charles Brown.

2180

```
MSH|^~\&|?|Saint-Louis|?|Saint-
Louis|20050530082015||ADT^A01^ADT_A01|000001|T|2.5|||FRA|8859/15|EN
EVN||20050530082000||1001^WHITE^Janine|20050530082000
PID|1||12345^^^Saint-Louis^PI||LAW^Robert^^^^^L||M|||||
987654^^^Saint-Louis^AN
ROL||AD|FHCP|7777^FAMILY^Bob
2185 PV1|1|I|||||2001^BROWN^Charles
ZBE|mvt1|20050530082000||INSERT|N
OBX||NM|3142-7^BODY WEIGHT (STATED)^LN||62|kg||||F
OBX||NM|8303-0^BODY HEIGHT^LN||1.70|m||||F
```

2190 The patient is redirected afterwards to another hospital. Janine White cancels the admission.

2195

```
MSH|^~\&|?|Saint-Louis|?|Saint-
Louis|20050530084400||ADT^A11^ADT_A09|000001|T|2.5|||FRA|8859/15|EN
EVN||20050530084350||1001^WHITE^Janine|20050530082000
PID|1||12345^^^Saint-Louis^PI||LAW^Robert^^^^^L||M|||||
987654^^^Saint-Louis^AN
PV1|1|I|||||2001^BROWN^Charles
ZBE|mvt1|20050530082000||CANCEL|N
```

## P.3 HL7 V3 Sample Messages

2200 The following examples are available online: see Appendix W.

The examples are organized by transaction.

### P.3.1 ITI-44 Patient Identity Feed HL7 V3 – Sample Messages

The XML files listed below are in the IHE Google Drive under [IHE Documents > TF Implementation Material > ITI > examples > PIXV3](#).

- 2205
- **Patient Registry Record Added message:** *01\_PatientRegistryRecordAdded1.xml*
  - **Patient Registry Record Revised message:** *04\_PatientRegistryRecordRevised2.xml*
  - **Patient Registry Duplicates Resolved message:** *05\_PatientRegistryDuplicatesResolved.xml*
- 2210
- **HL7 V3 Accept Acknowledgement message:** *02\_PatientRegistryRecordadded1Ack.xml*

### **P.3.2 ITI-45 PIXV3 Query – Sample Messages**

The XML files listed below are in the IHE Google Drive under [IHE Documents > TF Implementation Material > ITI > examples > PIXV3](#).

- **Patient Registry Get Identifiers Query message:** *06\_PIXQuery1.xml*
- 2215 • **Patient Registry Get Identifiers Query Response message:**  
*07\_PIXQuery1Response.xml*

### **P.3.3 ITI-46 PIXV3 Update Notification – Sample Messages**

The XML files listed below are in the IHE Google Drive under [IHE Documents > TF Implementation Material > ITI > examples > PIXV3](#).

- 2220 • **Patient Registry Record Revised message:** *04\_PatientRegistryRecordRevised2.xml*
- **HL7 V3 Accept Acknowledgement message:**  
*03\_PatientRegistryRecordAddedAck.xml*

### **P.3.4 ITI-47 Patient Demographics Query HL7 V3 – Sample Messages**

2225 The XML files listed below are in the [IHE Google Drive under IHE Documents > TF Implementation Material > ITI > examples > PDQV3](#).

- **Patient Registry Find Candidates Query message:** *01\_PDQQuery1.xml*
- **Patient Registry Find Candidates Query Response message:**  
*02\_PDQQuery1Response.xml*
- **General Query Activate Query Continue message:** *03\_PDQQuery1Continuation.xml*
- 2230 • **General Query Activate Query Continue Response message:**  
*04\_PDQQuery1ContinuationResponse.xml*
- **General Query Activate Query Cancel message:** *05\_PDQQuery1Cancel.xml*
- **General Query Activate Query Cancel Acknowledgment message:**  
*06\_PDQQuery1CancelAck.xml*

2235

## Appendix Q: HL7 V3 Sample Payload XML Schemas

The following examples are available online: see Appendix W.

The examples are organized by transactions.

### Q.1 ITI-44 Patient Identity Feed HL7 V3 – Sample Schemas

2240 The XSD files listed below are in the IHE Google Drive under [IHE Documents > TF Implementation Material > ITI > schema > HL7V3 > NE2008 > multicacheschemas](#).

- **Patient Registry Record Added schema:** *PRPA\_IN201301UV02.xsd*
- **Patient Registry Record Revised schema:** *PRPA\_IN201302UV02.xsd*
- **Patient Registry Duplicates Resolved schema:** *PRPA\_IN201304UV02.xsd*
- **HL7 V3 Accept Acknowledgment schema:** *MCCI\_IN000002UV01.xsd*

2245

### Q.2 ITI-45 PIXV3 Query – Sample Schemas

The XSD files listed below are in the IHE Google Drive under [IHE Documents > TF Implementation Material > ITI > schema > HL7V3 > NE2008 > multicacheschemas](#).

- **Patient Registry Get Identifiers Query schema:** *PRPA\_IN201309UV02.xsd*
- **Patient Registry Get Identifiers Query Response schema:** *PRPA\_IN201310UV02.xsd*

2250

### Q.3 ITI-46 PIXV3 Update Notification – Sample Schemas

The XSD files listed below are in the IHE Google Drive under [IHE Documents > TF Implementation Material > ITI > schema > HL7V3 > NE2008 > multicacheschemas](#).

- **Patient Registry Record Revised schema:** *PRPA\_IN201302UV02.xsd*
- **HL7 V3 Accept Acknowledgment schema:** *MCCI\_IN000002UV01.xsd*

2255

### Q.4 ITI-47 Patient Demographics Query HL7 V3 – Sample Schemas

The XSD files listed below are in the IHE Google Drive under [IHE Documents > TF Implementation Material > ITI > schema > HL7V3 > NE2008 > multicacheschemas](#).

- **Patient Registry Find Candidates Query schema:** *PRPA\_IN201305UV02.xsd*
- **Patient Registry Find Candidates Query Response schema:** *PRPA\_IN201306UV02.xsd*
- **General Query Activate Query Continue schema:** *QUQI\_IN000003UV01.xsd*
- **HL7 V3 Accept Acknowledgment schema:** *MCCI\_IN000002UV01.xsd*

2260

2265 **Appendix R: Mapping of HL7v2.5 to HL7v3 for PIX and PDQ****R.1 Data Types**

The following table describes the mapping between HL7 v2.5 and HL7 v3 data types:

HL7 v2.5 Data Type		HL7 v3 Data Type
HD (on the field level)		Instance Identifier (II)
Namespace ID		Assigning Authority Name (optional)
Universal ID		root
Universal ID Type		Not mapped – the universal ID/root must be an ISO OID
		extension is not used
CX		Instance Identifier (II)
ID (ST)		extension
Check digit (ST)		Not mapped
Code identifying the check digit (ST)		Not mapped
assigning authority (HD)	Namespace ID (IS)	Assigning Authority Name (optional)
	Universal ID (ST)	root
	Universal ID Type (IS) (required to be “ISO”)	Not mapped – the universal ID/root must be an ISO OID
identifier type code (ID)		Not mapped
assigning facility (HD)		Not mapped
effective date (DT)		ValidTime
expiration date (DT)		ValidTime
XPN		Person Name (PN)
ID Number (ST)		
Family Name (FN)		Family Part type
given name (ST)		Given Part type
Second or other given names or initials thereof (ST)		Given Part type – order of parts matters
suffix (e.g., JR or III) (ST)		Suffix Part type
prefix (e.g., DR) (ST)		Prefix Part type
degree (e.g., MD) (IS)		Suffix Part type
Name Representation code (ID)		
name context (CE)		
name validity range (DR)		ValidTime
name assembly order (ID)		
Name type code (ID)		Name Use Code

HL7 v2.5 Data Type	HL7 v3 Data Type
XTN	Telecom (TEL)
[999-] 999-9999 [x99999][C any text] (TN)	
telecommunication use code (ID)	Telecom Use Code
telecommunication equipment type (ID)	Reflected in the URL scheme of the URI (e.g., fax:) – see RFC2806
Email address (ST)	URL Scheme code = mailto
Country Code (NM)	Part of the tel: URI (see RFC3966)
Area/city code (NM)	Part of the tel: URI (see RFC3966)
Phone Number (NM)	Part of the tel: URI (see RFC3966)
Extension (NM)	Use of ";ext=" in the URI (see RFC3966)
any text (ST)	Not mapped

2270 **R.2 Add New Person Message**

Version 2.5 Conformance Profile					Version 3 Message					
Message Segment	Field Name	Components	Data Type	Conf	Message Information Model	Attribute Name	Data Type	Data Type Component Mapping Req'd?	Conf	Comments
MSH										
	Field Separator		ST	R		Not Applicable				
	Encoding Characters		ST	R		Not Applicable				
	Sending Application		HD	R	MCCI_RM00100IHE - Send Message Payload	Device.id	SET <II>		R	Mapped SET<II> data type components to v2.5 HD components. See table above.
		Namespace ID	IS	O				Y	R	
		Universal ID	ST	O				Y	R	
		Universal ID Type	ID	O				Y	R	
	Sending Facility		HD	R	MCCI_RM00100IHE - Send Message Payload	Organization.id	SET <II>		R	Mapped SET<II> data type components to v2.5 HD components. See table above.
		Namespace ID	IS	O				Y	R	
		Universal ID	ST	O				Y	R	
		Universal ID Type	ID	O				Y	R	



Version 2.5 Conformance Profile					Version 3 Message					
Message Segment	Field Name	Components	Data Type	Conf	Message Information Model	Attribute Name	Data Type	Data Type Component Mapping Req'd?	Conf	Comments
	Receiving Application		HD	R	MCCI_RM00100IHE - Send Message Payload	Device.id	SET <II>		R	Mapped SET<II> data type components to v2.5 HD components. See table above.
		Namespace ID	IS	O				Y		
		Universal ID	ST	O				Y		
		Universal ID Type	ID	O				Y		
	Receiving Facility		HD	R	MCCI_RM00100IHE - Send Message Payload	Organization.id	SET <II>		R	Mapped SET<II> data type components to v2.5 HD components. See table above.
		Namespace ID	IS	O				Y		
		Universal ID	ST	O				Y		
		Universal ID Type	ID	O				Y		
	Date/Time Of Message		TS	R	MCCI_RM00100IHE - Send Message Payload	Message.creationTime	TS	Y	R	
		Date/Time	NM	O	MCCI_RM00100IHE - Send Message Payload	Message.creationTime	TS	Y	R	

Version 2.5 Conformance Profile					Version 3 Message					
Message Segment	Field Name	Components	Data Type	Conf	Message Information Model	Attribute Name	Data Type	Data Type Component Mapping Req'd?	Conf	Comments
		Degree of Precision	ST	O						
	Security		ST	O	MCCI_RM00100IHE - Send Message Payload	Message.securityText	ST		O	
	Message Type		CM_MSG	R						
		Message type	ID	R	MCCI_RM00100IHE - Send Message Payload	Message.interactionId	II	Y	R	
		Trigger event	ID	R	MFMI_RM700200 - Registry Control Act	ControlActProcess.code	CD CWE	Y	R	
		Message structure	ID	R		Not mapped as interaction.Id expresses both message type and message structure				
	Message Control ID		ST	R		Message.id	II	Y	R	Only the id.root is valued
	Processing ID		PT	R	MCCI_RM00100IHE -	Message.processingCode	CS CNE		R	

Version 2.5 Conformance Profile					Version 3 Message					
Message Segment	Field Name	Components	Data Type	Conf	Message Information Model	Attribute Name	Data Type	Data Type Component Mapping Req'd?	Conf	Comments
					Send Message Payload					
		Processing ID	ID	O	MCCI_RM00100IHE - Send Message Payload	Message.pro cessingCode	CS CNE		R	
		Processing Mode	ID	O	MCCI_RM00100IHE - Send Message Payload	Message.pro cessingMode Code	CS CNE		R	
	Version ID		VID	R	MCCI_RM00100IHE - Send Message Payload	Message.vers ionCode	CS CNE		O	
		Version ID	ID	O	MCCI_RM00100IHE - Send Message Payload	Message.vers ionCode	CS CNE		O	
		Internationalizati on Code	CE	O						
		International version ID	CE	O						
	Sequence Number		NM	O	XCCI_RM00100 - Send Message Payload	Message.seq uenceNumbe r	INT		R	

Version 2.5 Conformance Profile					Version 3 Message					
Message Segment	Field Name	Components	Data Type	Conf	Message Information Model	Attribute Name	Data Type	Data Type Component Mapping Req'd?	Conf	Comments
	Continuation Pointer		ST	O						
	Accept Acknowledgment Type		ID	O	XCCI_RM000100 - Send Message Payload	Message.acceptAckCode	CS CNE		R	
	Accept Acknowledgment Type		ID	O	XCCI_RM000100 - Send Message Payload	Message.acceptAckCode	CS CNE		R	
	Country Code		ID	O						Mapped Country Code to AD data type. See table below.
	Character Set		ID	O						Part of the XML preamble
	Principal Language of Message		CE	O	MFMI_RM700200 - Registry Control Act	ControlActProcess.languageCode	CE CWE	Y	R	
		Identifier	ST					Y	R	
		Text	ST	O				Y	R	
		Name of coding system	IS	O				Y	R	
	Alternate Character Set Handling Scheme		ID	O						

Version 2.5 Conformance Profile					Version 3 Message					
Message Segment	Field Name	Components	Data Type	Conf	Message Information Model	Attribute Name	Data Type	Data Type Component Mapping Req'd?	Conf	Comments
	Conformance Statement ID		ID	O						
EVN										
	Event Type Code		ID	R	MFMI_RM7 00200 - Registry Control Act	ControlActProcess.code	CD CWE		O	
	Recorded Date/Time		TS	R	MFMI_RM7 00200 - Registry Control Act	ControlActProcess.effectiveTime	IVL<TS>		O	
		Date/Time	NM	O	MFMI_RM7 00200 - Registry Control Act	ControlActProcess.effectiveTime	IVL<TS>		O	
		Degree of Precision	ST	O						
	Date/Time Of Planned Event		TS	O						
		Date/Time	NM	O						
		Degree of Precision	ST	O						
	Event Reason Code		IS	RE	MFMI_RM7 00200 - Registry Control Act	ControlActProcess.reasonCode	SET <CE> CWE		O	

Version 2.5 Conformance Profile					Version 3 Message					
Message Segment	Field Name	Components	Data Type	Conf	Message Information Model	Attribute Name	Data Type	Data Type Component Mapping Req'd?	Conf	Comments
	Operator ID		XCN	R	MFMI_RM7 00200 - Registry Control Act	dataEnterer.typeCode	CE CWE	Y	R	
		ID Number (ST)	ST	R	MFMI_RM7 00200 - Registry Control Act			Y	R	Map to CMET (ASSIGNED) R_AssignedPerson (universal) COCT_MT090100
		Family Name	FN	O	MFMI_RM7 00200 - Registry Control Act			Y	R	Map to CMET (ASSIGNED) R_AssignedPerson (universal) COCT_MT090101 - PN data type
		given name	ST	O	MFMI_RM7 00200 - Registry Control Act			Y	R	Map to CMET (ASSIGNED) R_AssignedPerson (universal) COCT_MT090101 - PN data type
		Second or other given names or initials thereof	ST	O	MFMI_RM7 00200 - Registry Control Act			Y	R	Map to CMET (ASSIGNED) R_AssignedPerson (universal) COCT_MT090101 - PN data type
		suffix (e.g., JR or III)	ST	O	MFMI_RM7 00200 - Registry Control Act			Y	R	Map to CMET (ASSIGNED) R_AssignedPerson (universal)

Version 2.5 Conformance Profile					Version 3 Message					
Message Segment	Field Name	Components	Data Type	Conf	Message Information Model	Attribute Name	Data Type	Data Type Component Mapping Req'd?	Conf	Comments
										COCT_MT090101 - PN data type
		prefix (e.g., DR)	ST	O	MFMI_RM700200 - Registry Control Act			Y	R	Map to CMET (ASSIGNED) R_AssignedPerson (universal) COCT_MT090101 - PN data type
		degree (e.g., MD)	IS	O	MFMI_RM700200 - Registry Control Act			Y	R	Map to CMET (ASSIGNED) R_AssignedPerson (universal) COCT_MT090101 - PN data type
		source table	IS	O	MFMI_RM700200 - Registry Control Act			Y	R	Map to CMET (ASSIGNED) R_AssignedPerson (universal) COCT_MT090107 - II data type
		assigning authority	HD	R	MFMI_RM700200 - Registry Control Act			Y	R	Map to CMET (ASSIGNED) R_AssignedPerson (universal) COCT_MT090107 - II data type
		name type code	ID	O	MFMI_RM700200 - Registry Control Act			Y	R	Map to CMET (ASSIGNED) R_AssignedPerson (universal)

Version 2.5 Conformance Profile					Version 3 Message					
Message Segment	Field Name	Components	Data Type	Conf	Message Information Model	Attribute Name	Data Type	Data Type Component Mapping Req'd?	Conf	Comments
										COCT_MT090107 - II data type
		Identifier check digit	ST	O	MFMI_RM700200 - Registry Control Act			Y	R	Map to CMET (ASSIGNED) R_AssignedPerson (universal) COCT_MT090107 - II data type
		Code identifying the check digit scheme employed	ID	O	MFMI_RM700200 - Registry Control Act			Y	R	Map to CMET (ASSIGNED) R_AssignedPerson (universal) COCT_MT090107 - II data type
		identifier type code (IS)	IS	R	MFMI_RM700200 - Registry Control Act			Y	R	Map to CMET (ASSIGNED) R_AssignedPerson (universal) COCT_MT090107 - II data type
		assigning facility	HD	R	MFMI_RM700200 - Registry Control Act			Y	R	Map to CMET (ASSIGNED) R_AssignedPerson (universal) COCT_MT090107 - II data type
		Name Representation code	ID	O	MFMI_RM700200 - Registry Control Act			Y	R	Map to CMET (ASSIGNED) R_AssignedPerson (universal)



Version 2.5 Conformance Profile					Version 3 Message					
Message Segment	Field Name	Components	Data Type	Conf	Message Information Model	Attribute Name	Data Type	Data Type Component Mapping Req'd?	Conf	Comments
										COCT_MT090107 - II data type
		name context	CE	O	MFMI_RM700200 - Registry Control Act			Y	R	Map to CMET (ASSIGNED) R_AssignedPerson (universal) COCT_MT090107 - II data type
		name validity range	DR	O	MFMI_RM700200 - Registry Control Act			Y	R	Map to CMET (ASSIGNED) R_AssignedPerson (universal) COCT_MT090107 - II data type
		name assembly order	ID	O	MFMI_RM700200 - Registry Control Act			Y	R	Map to CMET (ASSIGNED) R_AssignedPerson (universal) COCT_MT090107 - II data type
	Event Occurred		TS	O						
		Date/Time	NM	O						
		Degree of Precision	ST	O						
	Event Facility		HD	O	MCCI_RM000100 - Send Message Payload	Organization.id	SET<II>	Y	R	Mapped SET<II> data type components to v2.5 HD

Version 2.5 Conformance Profile					Version 3 Message					
Message Segment	Field Name	Components	Data Type	Conf	Message Information Model	Attribute Name	Data Type	Data Type Component Mapping Req'd?	Conf	Comments
										components. See table above.
		Namespace ID	IS	O				Y	R	
		Universal ID	ST	O				Y	R	
		Universal ID type	ID	O				Y	R	
PID										
	Patient Identifier List		CX	RE	PRPA_RM2 01301IHE - Patient Activate/Revise					
		ID	ST	R		Patient.id OtherIDs.id	SET< II>	Y	R	Mapped II data type components to v2.5 CX components. See table above.
		Check digit	ST	O		Not applicable				
		Code identifying the check digit	ID	O		Not applicable				
		assigning authority	HD	R				Y		
		identifier type code (ID)	ID	R				Y		
		assigning facility	HD	R				Y		
		effective date (DT)	DT	RE		Patient.effectiveTime	IVL< TS>	N	O	

Version 2.5 Conformance Profile					Version 3 Message					
Message Segment	Field Name	Components	Data Type	Conf	Message Information Model	Attribute Name	Data Type	Data Type Component Mapping Req'd?	Conf	Comments
		expiration date	DT	RE				Y		
	Patient Name		XPN	RE	PRPA_RM2 01301IHE - Patient Activate/Rev ise					
		Family Name	FN	R		Person.name	LIST <PN>	Y	R	Mapped LIST<PN> and II data types components to v2.5 XPN components. See table below.
		given name	ST	O				Y		
		Second or other given names or initials thereof	ST	O				Y		
		suffix (e.g., JR or III)	ST	O				Y		
		prefix (e.g., DR)	ST	O				Y		
		degree (e.g., MD)	IS	O				Y		
		name type code	ID	R				Y		
		Name Representation code	ID	O				Y		
		name validity range	DR	O				Y		

Version 2.5 Conformance Profile					Version 3 Message					
Message Segment	Field Name	Components	Data Type	Conf	Message Information Model	Attribute Name	Data Type	Data Type Component Mapping Req'd?	Conf	Comments
		name assembly order	ID	O				Y		
	Mother's Maiden Name		XPN	RE	PRPA_RM2 01301IHE - Patient Activate/Revise	ParentClient.id				Reference CMET COCT_MT0302 00. Map LIST<PN> and II data types components to v2.4 CX components.
		Family Name	FN	R				Y		
		given name	ST	O				Y		
		Second or other given names or initials thereof	ST	O				Y		
		suffix (e.g., JR or III)	ST	O				Y		
		prefix (e.g., DR)	ST	O				Y		
		degree (e.g., MD)	IS	O				Y		
		name type code	ID	R				Y		
		Name Representation code	ID	O				Y		
		name context	CE	O				Y		
		name validity range	DR	O				Y		

Version 2.5 Conformance Profile					Version 3 Message					
Message Segment	Field Name	Components	Data Type	Conf	Message Information Model	Attribute Name	Data Type	Data Type Component Mapping Req'd?	Conf	Comments
		name assembly order	ID	O				Y		
	Date/Time of Birth		TS	RE	PRPA_RM2 0130IHE - Patient Activate/Revise					
		Date/Time	NM	R		Person.birthTime	TS		O	
		Degree of Precision	ST	O						
	Administrative Sex		IS	RE	PRPA_RM2 0130IHE - Patient Activate/Revise	Person.administrativeGenderCode	CS CNE		R	
	Patient Alias		XPN	O	PRPA_RM2 0130IHE - Patient Activate/Revise					Mapped PN and II data types components to v2.5 XPN components. See table above.
		Family Name	FN	O		Person.name	BAG <PN>	Y	R	
		given name	ST	O				Y	R	
		Second or other given names or initials thereof	ST	O				Y	R	
		suffix (e.g., JR or III)	ST	O				Y	R	

Version 2.5 Conformance Profile					Version 3 Message					
Message Segment	Field Name	Components	Data Type	Conf	Message Information Model	Attribute Name	Data Type	Data Type Component Mapping Req'd?	Conf	Comments
		prefix (e.g., DR)	ST	O				Y	R	
		degree (e.g., MD)	IS	O				Y	R	
		name type code	ID	O				Y	R	
		Name Representation code	ID	O				Y	R	
		name context	CE	O				Y	R	
		name validity range	DR	O				Y	R	
		name assembly order	ID	O				Y	R	
	Patient Address		XAD	RE	PRPA_RM2_0130IHE - Patient Activate/Revise					
		street address (SAD)	SAD	R		Person.addr	BAG <AD >	Y	R	Mapped AD data type components to v2.5 XAD components. See table below.
		city	ST	R				Y	R	
		state or province	ST	R				Y	R	
		zip or postal code	ST	R				Y	R	
		country	ID	R				Y	R	
		address type	ID	R				Y	R	

Version 2.5 Conformance Profile					Version 3 Message					
Message Segment	Field Name	Components	Data Type	Conf	Message Information Model	Attribute Name	Data Type	Data Type Component Mapping Req'd?	Conf	Comments
		address representation code	ID	O				Y	R	
		address validity range	DR	O				Y	R	
	Phone Number - Home		XTN	RE	PRPA_RM2 01301IHE - Patient Activate/Revise					
			TN	R		Person.telecom	BAG <TEL >	Y	R	Mapped TEL data type components to v2.5 XTN components. See table above.
		telecommunication use code	ID	R				Y	R	
		telecommunication equipment type (ID)	ID	O				Y	R	
		Email address	ST	O				Y	R	
		Country Code	NM	O				Y	R	
		Area/city code	NM	O				Y	R	
		Phone Number	NM	O				Y	R	
		Extension	NM	O				Y	R	
		any text	ST	O				Y	R	

Version 2.5 Conformance Profile					Version 3 Message					
Message Segment	Field Name	Components	Data Type	Conf	Message Information Model	Attribute Name	Data Type	Data Type Component Mapping Req'd?	Conf	Comments
	Phone Number - Business		XTN	RE						Mapped TEL data type components to v2.5 XTN components. See table above.
			TN	R				Y	R	
		telecommunication use code	ID	R				Y	R	
		telecommunication equipment type (ID)	ID	O				Y	R	
		Email address	ST	O				Y	R	
		Country Code	NM	O				Y	R	
		Area/city code	NM	O				Y	R	
		Phone Number	NM	O				Y	R	
		Extension	NM	O				Y	R	
		any text	ST	O				Y	R	
	Primary Language		CE	RE	PRPA_RM201301IHE - Patient Activate/Revise					
		Identifier	ST	O		LanguageCommunication.languageCode	CE CWE		R	
		text	ST	O					R	



Version 2.5 Conformance Profile					Version 3 Message					
Message Segment	Field Name	Components	Data Type	Conf	Message Information Model	Attribute Name	Data Type	Data Type Component Mapping Req'd?	Conf	Comments
		Name of coding system	IS	O					R	
	SSN Number - Patient		ST	O	PRPA_RM2 01301IHE - Patient Activate/Revise	OtherIDs.id	SET <II>		R	
	Driver's License Number - Patient		DLN	O	PRPA_RM2 01301IHE - Patient Activate/Revise	OtherIDs.id	SET <II>		R	
		Driver's License Number	ST	O				Y	R	Mapped II data type for DLN data type. See table above.
		Issuing State, province, country	IS	O				Y	R	
		expiration date	DT	O				Y	R	
	Mother's Identifier		CX	RE	PRPA_RM2 01301IHE - Patient Activate/Revise	PersonalRelationshipHolder.id	II	Y	R	Mapped II data type for CX data type. See table above.
		ID	ST	R				Y	R	
		Check digit	ST	O				Y	R	
		check identifying the check digit	ID	O				Y	R	

Version 2.5 Conformance Profile					Version 3 Message					
Message Segment	Field Name	Components	Data Type	Conf	Message Information Model	Attribute Name	Data Type	Data Type Component Mapping Req'd?	Conf	Comments
		scheme employed								
		assigning authority	HD	O				Y	R	
		identifier type code(ID)	ID	R				Y	R	
		assigning facility	HD	O				Y	R	
		effective date (DT)	DT	O				Y	R	
		expiration date	DT	O				Y	R	
	Ethnic Group		CE	O						
	Birth Order		NM	RE	PRPA_RM2 01301IHE - Patient Activate/Revise	Person.multipleBirthOrderNumber			R	
	Patient Death Date and Time		TS	RE	PRPA_RM2 01301IHE - Patient Activate/Revise			Y	R	
		Date/Time	NM	O	PRPA_RM2 01301IHE - Patient Activate/Revise	Person.deceasedTime	TS		O	
		Degree of Precision	ST	O						

Version 2.5 Conformance Profile					Version 3 Message					
Message Segment	Field Name	Components	Data Type	Conf	Message Information Model	Attribute Name	Data Type	Data Type Component Mapping Req'd?	Conf	Comments
	Patient Death Indicator		ID	RE	PRPA_RM2 0130IHE - Patient Activate/Revise	Person.deceasedInd	BL		O	
	Last Update Date/Time		TS	O						Metadata
		Date/Time	NM	O						Metadata
		Degree of Precision	ST	O						
	Last Update Facility		HD	O						Metadata
		Namespace ID	IS	O						Metadata
		Universal ID	ST	O						Metadata
		Universal ID type	ID	O						Metadata
NK1										
	Set ID - NK1		SI	R	PRPA_RM2 0130IHE - Patient Activate/Revise	PersonalRelationship.id				
	Name		XPN	O	COCT_MT0 30207UV - E_Person (informational) CMET	Person.name	LIST <PN>	Y	R	Mapped PN data type components to v2.5 XPN components. See table above.

Version 2.5 Conformance Profile					Version 3 Message					
Message Segment	Field Name	Components	Data Type	Conf	Message Information Model	Attribute Name	Data Type	Data Type Component Mapping Req'd?	Conf	Comments
		family name	FN	O				Y	R	
		given name	ST	O				Y	R	
		Second or other given names or initials thereof	ST	O				Y	R	
		suffix (e.g., JR or III)	ST	O				Y	R	
		prefix (e.g., DR)	ST	O				Y	R	
		degree (e.g., MD)	IS					Y	R	
		name type code	ID	O				Y	R	
		Name Representation code	ID	O				Y	R	
		name context	CE	O				Y	R	
		name validity range	DR	O				Y	R	
		name assembly order	ID	O				Y	R	
	Relationship		CE	R	PRPA_RM2 0130IHE - Patient Activate/Rev ise	PersonalRelationship.code			R	
		identifier	ST	O						
		text	ST	O						
		Name of coding system	IS	O						

Version 2.5 Conformance Profile					Version 3 Message					
Message Segment	Field Name	Components	Data Type	Conf	Message Information Model	Attribute Name	Data Type	Data Type Component Mapping Req'd?	Conf	Comments
	Date/Time of Birth		TS	O					R	
		Date/Time	NM	O				Y	R	
		Degree of Precision	ST	O				Y	R	
	Next of Kin/Associated Party's Identifiers		CX	R	COCT_MT030207UV – E_Person (informational) CMET	Person.id	SET<II>			Mapped II data type to CX data components. See table above.
		ID	ST	R				Y	R	
		Check digit	ST	O				Y	R	
		check identifying the check digit scheme employed	ID	O				Y	R	
		assigning authority	HD	R				Y	R	
		identifier type code(ID)	ID	R				Y	R	
		assigning facility	HD	R				Y	R	

**Appendix S: Intentionally Left Blank**

## Appendix T: Use of eMail (Informative)

2275 The off-line mode protocol uses the classical email exchange, based on SMTP server(s) as well as a POP3 server storing the recipient mailbox. The different steps of the exchange are described below, depending on the success or failure status of the exchange. The mechanism may be similar and use the evolution of these protocols (ESMTP, EMAP4). The Document Source and the Document Recipient shall at least support SMTP and POP3, but they may also support ESMTP and EMAP or similar. The example may also apply for a Document Repository when the off-line protocol binding is used.

2280

In case the message cannot reach the Document Recipient POP3 server, the diagram is the following:

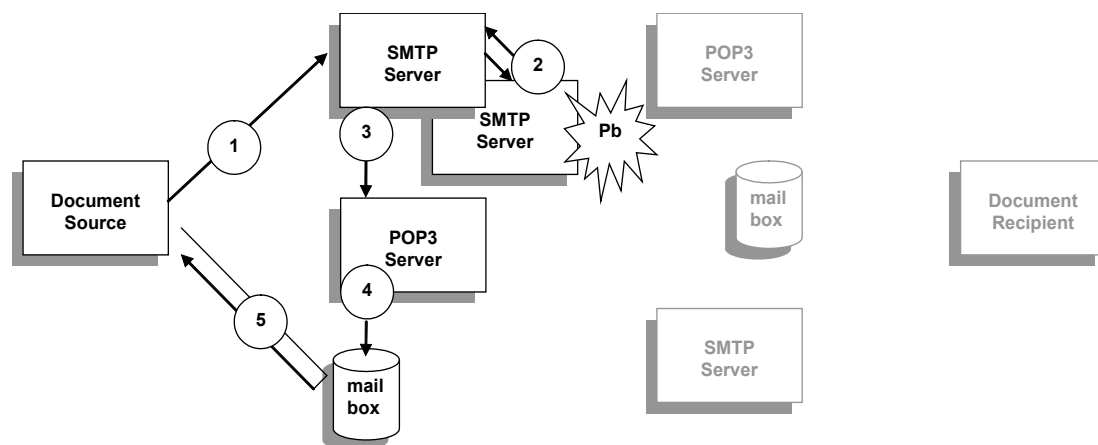

2285 **Figure T-1: Exchange diagram when the message is sent with error**

Where the steps are:

1. Initial message sent by the Document Source to its SMTP server
  2. Transfer of this message to the Document Recipient POP3 server, potentially through a number of other SMTP servers acting as relays, but with a problem arising (which could be also at the POP3 Server level as “user email unknown” or “over quota exceeded in the destination mailbox”). An error message “Delivery Status Notification” (DSN) is generated by the server where the problem occurs, and sent back to the sender (using its “reply to” address if present, its “from” address otherwise)
  3. Reception of the negative DSN message by the Document Source POP3 server
  4. Store of the received message by the POP3 server in the mail box dedicated to the Document Source
  5. Query and retrieve of the message by the Document Source from its mailbox (and normally deletion of this message).
- 2290
- 2295

In case the message reaches the Document Recipient POP3 server, the diagram is the following:

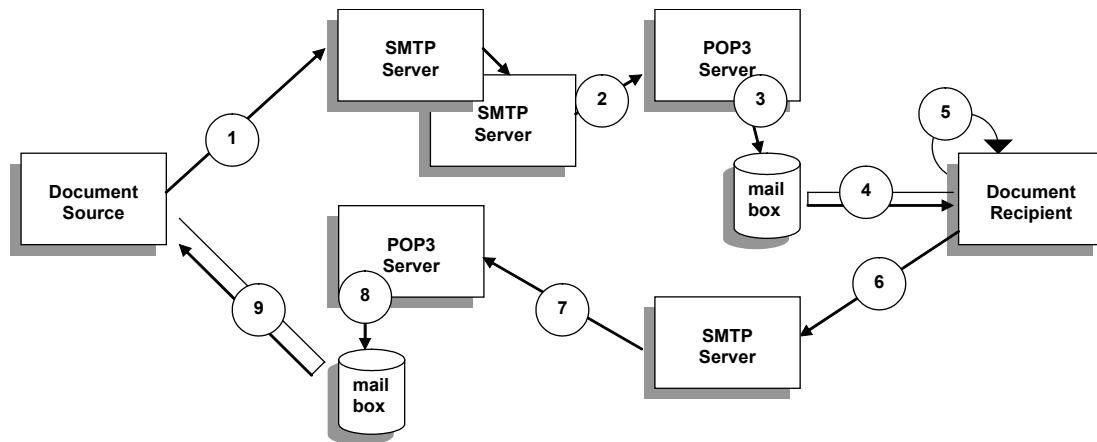

2300

**Figure T-2: Exchange diagram when the message is successfully sent**

Where the steps are:

1. Initial message sent by the Document Source to its SMTP server
- 2305 2. Transfer of this message to the Document Recipient POP3 server, potentially through a number of other SMTP servers acting as relays
3. Store of the received message by the POP3 server in the mail box dedicated to the Document Recipient
4. Query and retrieve of the message by the Document Recipient from its mailbox (and normally deletion of this message).
- 2310 5. Local confirmation of the success (or failure) when it “processes” the message inside the Document Recipient (which could be that the user has read the message or at least that it has been correctly imported in the EHR)
6. Generation by the Document Recipient of a “Message Delivery Notification” message, that can be positive (respectively negative with the status)
- 2315 7. Reception of the positive MDN message by the Document Source POP3 server
8. Store of the received message by the POP3 server in the mailbox dedicated to the Document Source
9. Query and retrieve of the message by the Document Source from its mailbox (and normally deletion of this message).



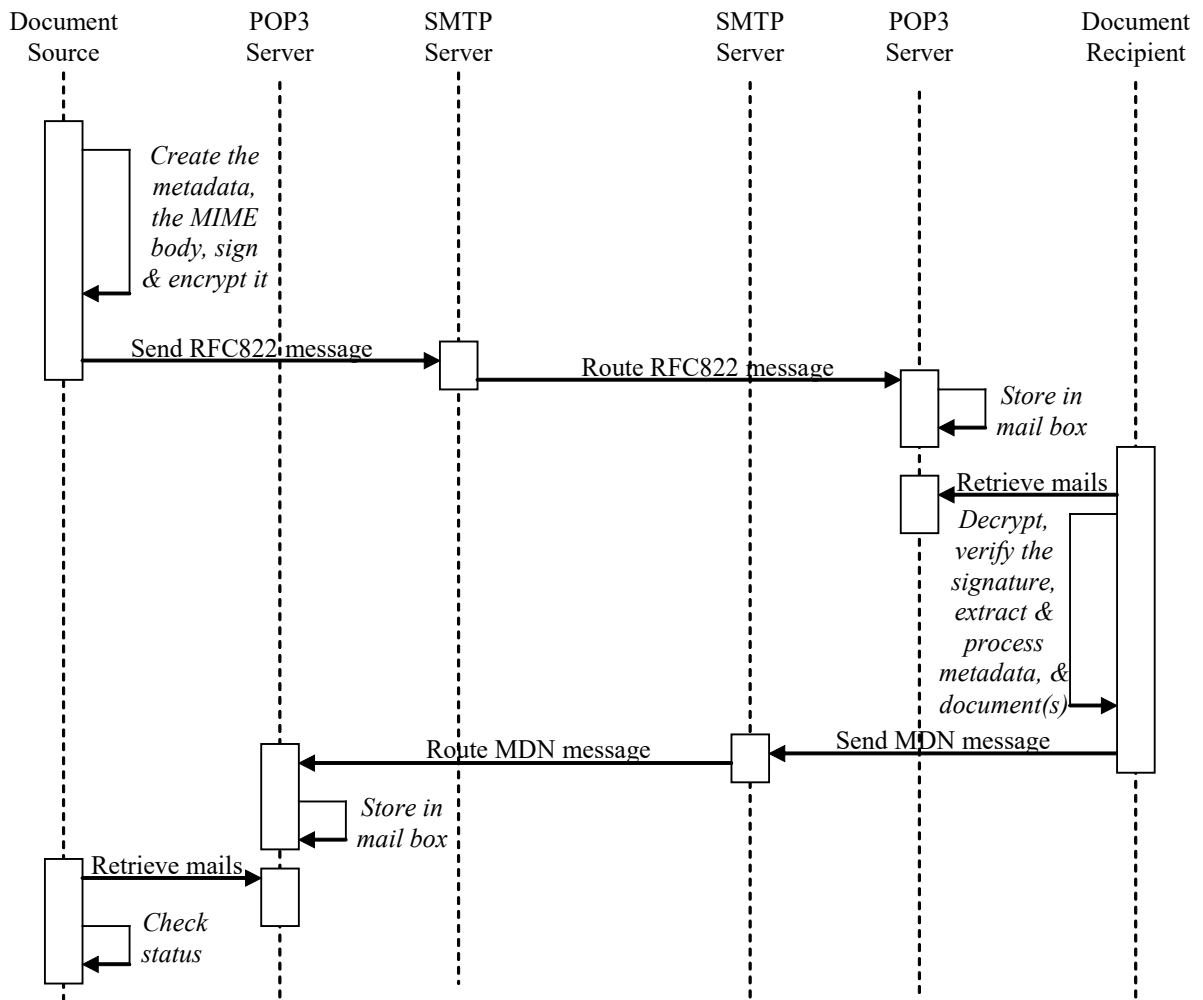

2320

**Figure T-3: Sequence diagram of a secured message exchange**

## **Appendix U: Intentionally Left Blank**

2325

## Appendix V: Web Services for IHE Transactions

### V.1 Introduction

2330 “Web Services” has become a catch-all phrase describing a wide range of HTTP transactions over a TCP/IP network. A more precise definition of Web Services implies richer infrastructure capabilities with all transactions built using SOAP messages. This appendix provides the guidelines for specifying the use of SOAP-based Web Services as the messaging infrastructure and transport mechanism for IHE transactions.

### V.2 Relevant Standards

2335 Virtually all web services specifications are developed under the auspices of the World Wide Web Consortium (W3C) or the Organization for the Advancement of Structured Information Standards (OASIS). The Web Services-Interoperability organization (WS-I) publishes profiles, which incorporate several existing standards, and constrain them for interoperability. For each profile, WS-I also publishes a test assertion document and corresponding interoperability testing  
2340 tools for Java and C#.

#### V.2.1 WS-I Profiles

The Web Services for IHE transactions will be based on SOAP 1.2, and as such they take advantage of the guidelines expressed in the WS-I Basic Profile 2.0 (BP 2.0). Some IHE  
2345 transactions may also take advantage of the WS-I Basic Security Profile 1.1 (BSP 1.1) and WS-I Reliable Secure Profile 1.0 (RSP 1.0) where applicable.

#### V.2.2 WS-\* Specifications

Based on the requirements of the current WS-I profiles, the Web Services for IHE transactions support the following Web Services standards:

- WS-Addressing
- 2350 • MTOM
- XOP
- WS-Security

The WS-I Reliable Secure Profile combines several of the above WS-\* standards, as well as including:

- 2355 • WS-SecureConversation
- WS-Trust
- WS-Policy
- WS-ReliableMessaging

2360 In the future, the Web Services for IHE transactions will consider support for this new WS-I profile, or particular WS-\* standards as needed by specific use cases.

### V.2.3 HL7 Web Services Profile

2365 The HL7 Web Services Profile provides a framework for using Web Services as the transport mechanism for HL7 V3 messages. The framework provides a layered approach to specifying Web Services requirements. IHE will use the same approach as a guideline when specifying Web Services transport for IHE transactions and will do its best to maintain this consistency over time.

### V.2.4 XML Namespaces

Table V.2.4-1 lists XML namespaces that are used in this appendix. The choice of any namespace prefix is arbitrary and not semantically significant.

2370

**Table V.2.4-1: XML Namespaces and Prefixes**

Prefix	Namespace	Specification
wsdl (or default)	http://schemas.xmlsoap.org/wsdl/	<a href="#">WSDL 1.1 binding for SOAP 1.2</a>
wsoap12 or wsoap	http://schemas.xmlsoap.org/wsdl/soap12/	<a href="#">WSDL 1.1 binding for SOAP 1.2</a>
wsaw	http://www.w3.org/2006/05/addressing/wsdl	<a href="#">WSA 1.0 - WSDL Binding</a>
wsa	http://www.w3.org/2005/08/addressing	<a href="#">WSA 1.0 - Core</a>
wsam	http://www.w3.org/2007/05/addressing/metadata	<a href="#">WSA 1.0 - Metadata</a>
soap12	http://www.w3.org/2003/05/soap-envelope	<a href="#">SOAP 1.2</a>
soap	Either soap11 or soap12 depending on context	
HL7	urn:hl7-org:v3	HL7 V3 XML ITS
xsd	http://www.w3.org/2001/XMLSchema	<a href="#">XML Schema</a>
xsi	http://www.w3.org/2001/XMLSchema-instance	<a href="#">XML Schema</a>
lcm	urn:oasis:names:tc:ebxml-regrep:xsd:lcm:3.0	
rim	urn:oasis:names:tc:ebxml-regrep:xsd:rim:3.0	
rs	urn:oasis:names:tc:ebxml-regrep:xsd:rs:3.0	
query	urn:oasis:names:tc:ebxml-regrep:xsd:query:3.0	
xds	urn:ihe:iti:xds-b:2007	
xop	http://www.w3.org/2004/08/xop/include	

## V.3 Web Services Requirements

The requirements in this section represent guidance for IHE Technical Framework authors who need to use web services in specific transactions. These requirements fall into two categories:

2375

1. Providing consistency and clarity in the IHE specifications.
2. Affecting the wire format of the transactions.

When the requirements for particular text are specified, the following notation is used:

- curly braces (i.e., {}) are used to denote a part of a string which shall always be replaced with a string corresponding to the specific transaction, actor, or profile;
- 2380 • square brackets (i.e., []) are used to denote a part of a string which shall be either replaced with a string corresponding to the specific transaction, or shall be completely omitted.

### **V.3.1 Requirements for Transactions using HL7 V3 Messages**

When IHE transactions use HL7 V3 Messages, the Web Services protocol will conform to the HL7 Web Services Basic, Addressing, Security, and Reliable Messaging Profiles, with additional  
2385 constraints as specified in the following sub-sections.

#### **V.3.1.1 HL7 WS Basic Profile Constraints**

The Sender and Receiver shall conform to the HL7 WS Basic Profile with five modifications. The first modification is the requirement of supporting SOAP 1.2, while the HL7 WS Basic Profile provides the choice of supporting either SOAP 1.1 or SOAP 1.2, or both.

2390 The second modification is to HL7-WSP200, which recommends that a WSDL document describes a specific HL7 application role. For consistency with non-HL7 V3 transactions, IHE specifications shall provide an example WSDL document for all transactions of an actor per profile (see IHE-WSP200).

2395 The third modification is to HL7-WSP201, which recommends that the HL7 Application Role ID is to be used as the name of the WSDL definition. For consistency with non-HL7 V3 transactions the name of the example WSDL definition provided in the IHE specification shall be the actor name of the transaction's receiver (see the IHE-WSP201).

2400 The fourth modification is to HL7-WSP202, which specifies the use of the HL7 namespace as the target namespace of the WSDL document. This would prevent creating a single WSDL for actors which use both HL7 V3 and non-HL7 V3 IHE transactions (e.g., an XDS registry implementing the XDS.b Profile with the Patient Identity Feed HL7 V3 transaction). For consistency among all IHE transactions, when creating an IHE transaction specification, the WSDL target namespace shall be specified as “urn:ihe:<committee name>:<profile>:<year> (see IHE-WSP202).

2405 The fifth modification is to HL7-WSP208, which specifies that “WSDL messages for Interactions SHOULD use wsdl:operation/wsdl:input/@wsa:Action = “urn:hl7-org:v3:{Interaction\_Artifact\_Id}”. IHE extends the “should” to support situations where one HL7 message is being used within two transactions for significantly different purposes. For this case the second use of the message shall extend the HL7 specified Action string with  
2410 “[transaction-name]” where [transaction-name] is the name of the second transaction.

#### **V.3.1.2 HL7 WS Addressing Profile Constraints**

The Sender and Receiver should conform to the HL7 WS Addressing Profile. No additional constraints are made in this sub-section.

**V.3.1.3 HL7 WS Security Profile Constraints**

2415 IHE does not specify whether the Sender and Receiver should implement the HL7 WS Security Profile. The decision to implement the HL7 WS Security Profile is left to implementers. Each IHE transaction specifies its ATNA requirements for security and authentication. Security profiles such as Cross-Enterprise User Assertion (XUA) contain further security requirements.

2420 With the publication of WS-Security 1.1 and when the WS-I Basic Security Profile 1.1 is released, it is expected that ATNA (or a different profile) may incorporate additional options for Web Services, and the HL7 WS Security Profile will be incorporated in this appendix.

**V.3.1.4 HL7 WS Reliable Messaging Profile Constraints**

2425 IHE does not specify whether the Sender and Receiver should implement the HL7 WS Reliable Messaging Profile. The decision to implement the HL7 WS Reliable Messaging Profile is left to implementers. When the WS-I Reliable Secure Profile Working Group releases a profile it is expected that additional options for Web Services may be added, and the HL7 WS Reliable Messaging Profile will be incorporated in this appendix.

**V.3.2 Requirements for Transactions which don't use HL7 V3 Messages**

2430 The following IHE web services requirements are derived from the HL7 Web Services Profile. This provides consistency among the IHE transactions, compatibility to existing Web Services implementations through the WS-I profiles, and a well-defined mechanism for adding additional layers of web services in the future. The HL7 Web Services Profile also provides detailed background regarding the requirements presented here.

The numbering scheme for the individual requirements uses the following convention:

- 2435 • IHE-WS[P|A|S|RM]nnn[.e]) text

P, A, S, and RM represent the Basic, Addressing, Security, and Reliable Messaging requirements sections in this specification, nnn represents a unique number for this specification, and text is the text of the requirement. This directly corresponds to the convention used in the HL7 Web Services Profile, and for easier navigation, the same numbers correspond to the equivalent requirements in both specifications. Note that not all implementation decisions from the HL7 Web Services Profile are relevant for non-HL7 web services transactions. If there are cases where an IHE Web Services requirement exists that does not correspond to an implementation decision from the HL7 Web Services Profile, the optional extension to the number (shown as .e above) can be used to eliminate the possibility of confusion.

2445 **Table V.3.2-1: Web Services Requirements for Non-HL7 Transactions**

Requirement Identifier	Requirement text	SOAP message format affected?
IHE-WSP200	Example WSDL documents shall implement a specific IHE actor within a specific IHE Integration Profile.	No
IHE-WSP201	The attribute /wsdl:definitions/@name in the example WSDL document provided with an IHE specification shall be the name of the IHE actor providing the service.	No

Requirement Identifier	Requirement text	SOAP message format affected?
IHE-WSP202	The targetNamespace of the example WSDL shall be urn:ihe:{committee}:{profile}:{year}	No
IHE-WSP203	The example WSDL shall include XML Schema Definition references for the transactions payloads.	No
IHE-WSP205	Two WSDL messages shall be defined for a request-response transaction.	No
IHE-WSP206	In the example WSDL provided by an IHE specification a single WSDL part named Body shall be defined for each WSDL message and the part type shall refer to an element defined in the Schema Definition required in IHE-WSP203.	Determines the format of the SOAP Body
IHE_WSP207	For each input and output message defined in the WSDL portType operation an attribute wsaw:Action SHALL be included.	No
IHE_WSP208	WSDL operations SHALL use <b>wsdl:operation/wsdl:input/@wsaw:Action = "urn:ihe:{committee}:{Year}::{Transaction name}[Operation]"</b> and <b>wsdl:operation/wsdl:output/@wsaw:Action = "urn:ihe:{committee}:{Year}::{Transaction name}[Operation]Response"</b>	Determines the SOAP header content for wsa:Action
IHE_WSP211	Operations defined in the WSDL portType may or may not have a wsoap12:operation/@soapAction attribute provided. If wsoap12:operation/@soapAction is not provided, wsoap12:operation/@soapActionRequired shall be false. SOAP message consumers shall ignore any soapAction value found in a SOAP message.	Determines the value of soapAction
IHE_WSP212	The example WSDL provided with an IHE specification shall use the SOAP Binding described in <a href="#">WSDL 1.1 Chapter 3</a> and the <a href="#">binding extension for SOAP 1.2</a> .	No
IHE_WSP215	IHE transactions referencing the standards specified by Appendix V shall support SOAP 1.2, unless otherwise noted in the transaction. The example WSDL document provided with an IHE specification shall contain a SOAP 1.2 binding unless the transaction specifically notes that SOAP 1.2 is not supported.	Determines the namespace of the SOAP message
IHE_WSA100	The example WSDL provided with IHE transactions shall use the WS-Addressing framework when specifying the Web Services protocol.	Determines the WSA content for the SOAP header
IHE_WSA101	All <wsa:Action> elements shall have the mustUnderstand attribute set (mustUnderstand="1" or "true")	Ensures that web services frameworks are configured to properly generate and process WS-Addressing headers
IHE_WSA102	The <wsa:ReplyTo> element of the initiating message shall be present. (See Note 1.)	Ensures that responses are routed to the appropriate web services end point, or as an immediate response

Note 1: There may be web services toolkits which implement the WS-Addressing features improperly and may have problems processing a wsa:ReplyTo header with a mustUnderstand attribute set to true. Implementers of SOAP

clients are advised to plan for mitigating the impact of toolkits with deficient implementation of WS-Addressing by putting the mustUnderstand attribute only on other header(s).

## 2450 V.3.2.1 Basic Requirements

### V.3.2.1.1 Naming conventions and namespaces

**IHE-WSP200)** Example WSDL documents shall implement a specific IHE actor within a specific IHE Integration Profile.

2455 This editorial requirement means that if several IHE actors within a profile are combined, then separate WSDL documents for each actor need to be provided. This only applies to actors, which provide a particular service, i.e., the receivers in an IHE transaction.

**IHE-WSP201)** IHE requires the profile writers and recommends the implementers to use the following naming convention for WSDL artifacts.

- 2460 • **NAME** – represents the formal IHE actor name of the actor providing the service with spaces omitted from the name (e.g., DocumentRegistry is the **NAME** value for the XDS.b Document Registry Actor). Specifically, **NAME** is the value of the `/wsdl:definitions/@name` attribute which will be specified for each transaction.
- 2465 • **Transaction Name** – represents the formal IHE Transaction Name for this particular web-service exchange with spaces omitted from the name (e.g., RegistryStoredQuery is the **TRANSACTION\_** for the XDS.b Registry Stored Query Transaction)

WSDL Artifact	Proposed Naming
message request	{Transaction Name}_Message
message response	{Transaction Name}Response_Message
portType	{NAME}_PortType
Operation	{NAME}_{Transaction Name}[_ OperationID]
SOAP 1.2 binding	{NAME}_Binding_Soap12
SOAP 1.2 port	{NAME}_Port_Soap12

Here is an example of how the nomenclature is applied:

For `wsdl:definitions/@name="DocumentRegistry"`:

```

2470 message request -> "RegistryStoredQuery_Message"
message response -> RegistryStoredQueryResponse_Message
portType -> "DocumentRegistry_PortType"
operation -> "DocumentRegistry_RegistryStoredQuery_Request"
SOAP 1.2 binding -> "DocumentRegistry_Binding_Soap12"
SOAP 1.2 port -> "DocumentRegistry_Port_Soap12"

```

2475



### **IHE-WSP202)**

IHE requires the use of the following naming convention for targetNamespace of example WSDL.

- 2480       • DOMAIN – represents the acronym of the IHE domain who authored this web-service transaction (e.g., iti)
- PROFILE – represents the acronym of the IHE profile which references this web-service transaction (e.g., xds-b)
- YEAR – represents the four-digit year that this transaction was first published within a Trial Implementation profile
- 2485       • TYPE – optional extension of which other IHE specifications already using XML namespaces may make use

The targetNamespace of the example WSDL shall be

urn:ihe:{DOMAIN}:{PROFILE}:{YEAR} and may be extended to

urn:ihe:{DOMAIN}:{PROFILE}:{YEAR}:{TYPE}

2490       As an example the namespace for the 2008 XDS.b Integration Profile is urn:ihe:iti:xds-b:2007.

**IHE-WSP203)** The example WSDL shall include XML Schema Definition references for the transactions payloads.

The purpose of this requirement is to specify how authors of IHE profiles specify the transactions which use web services. This requires both the existence of an XML schema definition for the transaction payloads, and the manner in which it is specified in the WSDL file – by reference.

2495

### **V.3.2.1.2 Message and portType Definitions**

**IHE-WSP205)** Two WSDL messages shall be defined for a request-response transaction.

2500

**IHE-WSP206)** In the example WSDL provided by an IHE specification a single WSDL part named Body shall be defined for each WSDL message and the part type shall refer to an element defined in the Schema Definition required in IHE-WSP203.

**IHE-WSP207)** For each input and output message defined in the WSDL portType operation an attribute wsaw:Action SHALL be included.

2505

For compatibility with the Addressing requirements and consistency with naming across IHE Web Services implementations, the wsaw:Action attribute for each WSDL input and output message must be defined.

The wsaw:Action attribute shall be ignored by Web Services implementations that do not support WS-Addressing. It is very important to have the attribute in mixed cases where just one of the endpoints might support the WS-Addressing specification to avoid communication or routing errors.

2510

**IHE-WSP208)** WSDL operations SHALL use **wsdl:operation/wsdl:input/@wsaw:Action = "urn:ihe:{Domain}:{Year}:{Transaction name}"** and

**wsdl:operation/wsdl:output/@wsaw:Action = "urn:ihe:{Domain}:{Year}:{Transaction name}Response"**

- 2515 For example, the wsaw:Action value for the Registry Stored Query [ITI-18] transaction is specified as “urn:ihe:iti:2007:RegistryStoredQuery” and “urn:ihe:iti:2007:RegistryStoredQueryResponse”.

### V.3.2.1.3 Binding

- 2520 Multiple WSDL bindings can be defined in order to support different protocols and transports. The naming is consistent with the naming rules specified in the previous section.

**IHE-WSP211)** Operations defined in the WSDL portType may or may not have a wsoap12:operation/@soapAction attribute provided. If wsoap12:operation/@soapAction is not provided, wsoap12:operation/@soapActionRequired shall be false.

SOAP message consumers shall ignore any soapAction value found in a SOAP message.

- 2525 **IHE-WSP212)** The example WSDL provided with an IHE specification shall use the SOAP Binding described in [WSDL 1.1 Chapter 3](#) and the [binding extension for SOAP 1.2](#).

- 2530 **IHE-WSP215)** IHE transactions referencing the standards specified by Appendix V shall support SOAP 1.2, unless otherwise noted in the transaction. The example WSDL document provided with an IHE specification shall contain a SOAP 1.2 binding unless the transaction specifically notes that SOAP 1.2 is not supported.

SOAP 1.2 is the base standard for several WS specification, and has many available and easily accessible implementations.

#### Example 1: Example WSDL File with a Non-HL7 Transaction

- ```

2535 <definitions xmlns:wsoap11="http://schemas.xmlsoap.org/wsdl/soap/"
      xmlns="http://schemas.xmlsoap.org/wsdl/"
      xmlns:xsd="http://www.w3.org/2001/XMLSchema"
      xmlns:ihe="urn:ihe:iti:xds-b:2007" xmlns:rs="urn:oasis:names:tc:ebxml-
2540 regrep:xsd:rs:3.0"
      targetNamespace="urn:ihe:iti:xds-b:2007"
      xmlns:wsoap12="http://schemas.xmlsoap.org/wsdl/soap12/"
      xmlns:wsaw="http://www.w3.org/2007/05/addressing/wsdl"
      name="XDSRepository">
2545   <documentation>IHE XDS Document Repository</documentation>
   <types>
     <xsd:schema elementFormDefault="qualified">
       <xsd:import namespace="urn:oasis:names:tc:ebxml-
2550 regrep:xsd:rs:3.0"
         schemaLocation="../schema/ebXML_RS/rs.xsd"/>
       <xsd:import namespace="urn:ihe:iti:xds-b:2007"
         schemaLocation="../schema/IHE/IHEXDS.xsd"/>
     </xsd:schema>
   </types>
   <message name="RetrieveDocumentSet_Message">
2555     <documentation>Retrieve Document Set</documentation>
     <part name="body" element="ihe:RetrieveDocumentSetRequest"/>

```

```

2560 </message>
      <message name="RetrieveDocumentSetResponse_Message">
        <documentation>Retrieve Document Set Response</documentation>
        <part name="body" element="ihe:RetrieveDocumentSetResponse"/>
      </message>
      <message name="ProvideAndRegisterDocumentSet_Message">
        <documentation>Provide and Register Document Set</documentation>
2565 element="ihe:ProvideAndRegisterDocumentSetRequest"/>
      </message>
      <message name="ProvideAndRegisterDocumentSetResponse_Message">
        <documentation>Provide And Register Document Set
2570 Response</documentation>
        <part name="body" element="rs:RegistryResponse"/>
      </message>
      <portType name="XSDSDocumentRepository_PortType">
        <operation name="ProvideAndRegisterDocumentSet">
          <input message="ihe:ProvideAndRegisterDocumentSet_Message"
2575 wsaw:Action="urn:ihe:iti:2007:ProvideAndRegisterDocumentSet-
b"/>
          <output
message="ihe:ProvideAndRegisterDocumentSetResponse_Message"
2580 wsaw:Action="urn:ihe:iti:2007:ProvideAndRegisterDocumentSet-
bResponse"/>
          </operation>
          <operation name="RetrieveDocumentSet">
            <input message="ihe:RetrieveDocumentSet_Message"
2585 wsaw:Action="urn:ihe:iti:2007:RetrieveDocumentSet"/>
            <output message="ihe:RetrieveDocumentSetResponse_Message"
wsaw:Action="urn:ihe:iti:2007:RetrieveDocumentSetResponse"/>
          </operation>
        </portType>
2590 <binding name="XSDSDocumentRepository_Binding_Soap11"
type="ihe:XSDSDocumentRepository_PortType">
      <wssoap11:binding style="document"
transport="http://schemas.xmlsoap.org/soap/http"/>
      <operation name="ProvideAndRegisterDocumentSet">
2595 <wssoap11:operation
soapAction="urn:ihe:iti:2007:ProvideAndRegisterDocumentSet-b"/>
        <input>
          <wssoap11:body use="literal"/>
        </input>
        <output>
2600 <wssoap11:body use="literal"/>
        </output>
      </operation>
      <operation name="RetrieveDocumentSet">
2605 <wssoap11:operation
soapAction="urn:ihe:iti:2007:RetrieveDocumentSet"/>
        <input>
          <wssoap11:body use="literal"/>
        </input>
        <output>
2610 <wssoap11:body use="literal"/>
        </output>

```

```

    </operation>
  </binding>
  <binding name="XSDDocumentRepository_Binding_Soap12"
2615 type="ihe:XSDDocumentRepository_PortType">
    <wssoap12:binding style="document"
transport="http://schemas.xmlsoap.org/soap/http"/>
    <operation name="ProvideAndRegisterDocumentSet">
2620 <wssoap12:operation
soapAction="urn:ihe:iti:2007:ProvideAndRegisterDocumentSet-b"/>
      <input>
        <wssoap12:body use="literal"/>
      </input>
      <output>
2625 <wssoap12:body use="literal"/>
      </output>
    </operation>
    <operation name="RetrieveDocumentSet">
2630 <wssoap12:operation
soapAction="urn:ihe:iti:2007:RetrieveDocumentSet"/>
      <input>
        <wssoap12:body use="literal"/>
      </input>
      <output>
2635 <wssoap12:body use="literal"/>
      </output>
    </operation>
  </binding>
  <service name="XSDDocumentRepository_Service">
2640 <port name="XSDDocumentRepository_Port_Soap11"
binding="ihe:XSDDocumentRepository_Binding_Soap11">
    <wssoap11:address
location="http://servicelocation/XSDDocumentRepository_Service"/>
  </port>
2645 <port name="XSDDocumentRepository_Port_Soap12"
binding="ihe:XSDDocumentRepository_Binding_Soap12">
    <wssoap12:address
location="http://servicelocation/XSDDocumentRepository_Service"/>
  </port>
2650 </service>
</definitions>

```

### V.3.2.2 Addressing Requirements

2655 The Web Services Addressing specification (WS-Addressing) defines a framework for a transport-neutral SOAP messaging. Although understanding the concepts outlined in WS-Addressing is important, most of the underlying details will be shielded by the abstraction layers provided to developers. This specification assumes an abstract separation between the application layer, the Web services messaging infrastructure layer, and the message transport layer.

2660 The IHE transaction is built at the application layer, it is passed to the Web services messaging infrastructure layer where the SOAP message is constructed according to the rules set in the

2665 WSDL. The action value specified in the WSDL is used to construct the <wsa:Action> SOAP header. The endpoint address specified in the WSDL (or the supplied end point reference) is used to construct the <wsa:To>. Depending on the message exchange pattern (e.g., one-way, request-response), other WS-Addressing headers may be added at this point (e.g., <wsa:From>, <wsa:ReplyTo>, etc.).

IHE-WSA100) The example WSDL provided with IHE transactions shall use the WS-Addressing framework when specifying the Web Services protocol.

2670 IHE-WSA101) All <wsa:Action> elements shall have the mustUnderstand attribute set (mustUnderstand="1" or "true")

IHE-WSA102) The <wsa:ReplyTo> element of the initiating message shall be present.

2675 Note: There may be web services toolkits which implement the WS-Addressing features improperly and may have problems processing a wsa:ReplyTo header with a mustUnderstand attribute set to true. Implementers of SOAP clients are advised to plan for mitigating the impact of toolkits with deficient implementation of WS-Addressing by putting the mustUnderstand attribute only on other header(s).

See Section V.9.2 for sample headers for Synchronous and Asynchronous messages.

### **V.3.2.3 Security Requirements**

2680 The IHE ATNA Profile contains requirements which address certain aspects of security and authentication, including HTTPS transport requirements. Individual transactions which use Web Services will incorporate these requirements depending on their needs. Security profiles such as Cross-Enterprise User Assertion (XUA) Profile contain further security requirements. With the publication of the WS-I Basic Security Profile it is expected that ATNA will incorporate additional options for Web Services, and this appendix will reflect any requirements specific for Web Services for IHE transactions.

## **V.4 Web Services for specific IHE Transactions**

2690 The Web Services specification is provided in three parts. The first part will be in Volumes 2a, 2b and 2c, where a separate subsection shall be added for each affected IHE transaction at the end of the "Message Semantics" section. This subsection shall detail the types and message parts of the WSDL. The actor-specific constraints against the IHE Web Services Requirements specified above shall be added at the end of each "Expected Actions" section.

2695 The second, informative part of the specification is online: see Appendix W which contains a complete WSDL (Web Services Description Language) description of the web service, which aggregates the snippets from Volumes 2a, 2b and 2c described above. There will be one WSDL contract per actor per profile. Each transaction is represented by a port type, where the operations names and message names follow the requirements specified in Section V.3.2.1.1. The complete WSDL is for reference purposes for implementers.

## V.5 Synchronous and Asynchronous Web Services Exchange

### V.5.1 Overview

2700 When two actors, later referred to as Requestor and Provider, need to exchange web services messages using a request-response message exchange pattern, they can do so synchronously or asynchronously.

2705 With synchronous message exchange, the Requestor sends a request and blocks waiting for a response from the Provider. The Requestor receives the response on the same connection that the Requestor initially established to send the request. Synchronous exchange is usually easier to implement and requires that the Provider be available when the Requestor needs to send a request.

2710 With asynchronous message exchange, the Requestor is only concerned with sending the request, knowing that it will ‘eventually’ receive a response. The Provider may not be available at the time the request is sent. When the Provider receives and processes the message it sends a response back to the Requestor over a new connection. Asynchronous Web Services Exchange enables support for network infrastructures where:

- Transports are unreliable
- Systems are not always available
- Variable or high communication latency is present

### 2715 V.5.2 Considerations for using Asynchronous Web Services Exchange

2720 Asynchronous Web Services Exchange opens the option for using intermediaries for store and forward or offline communication modes, and leveraging reliable messaging mechanisms to address the reliability and availability challenges that these types of network infrastructures present. Asynchronous Web Services Exchange enables support for clinical use cases that can benefit from asynchronous infrastructure capabilities such as offline mode.

Adding support for asynchronous exchange should take into consideration the fact that:

- The request and response messages are decoupled and transmitted on separate connections as shown in Figure V.5.2-1 below.
  - The Requestor will ‘unblock’ before it receives the response. The response will be received asynchronously at a later time. Having decoupled request/response exchange should draw attention to the following:
    - The Requestor should have response timeout capability to handle the case when a response has not been received within expected time interval
    - The Requestor should be able to match request/response pairs
- 2725

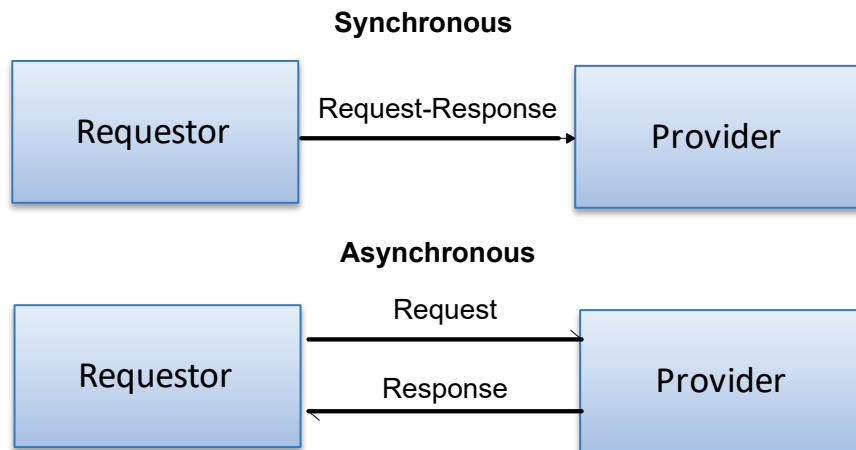

2730

**Figure V.5.2-1: Request and Response Messages**

### V.5.3 Specification of the use of Asynchronous Web Services Exchange

Volume 2a, 2b and 2c transaction specifications will identify whether asynchronous support is required or optional on the transaction level. If nothing is specified in Volume 2a/2b/2c, only synchronous exchange is expected. When optional asynchronous support is applicable to a transaction, the profile specification in ITI TF-1 will identify that support as required for actors in that profile or as a named option.

2735

## V.6 Web Services Standards Evolution

As the industry acceptance of newer standards/newer versions of existing standards progresses, new options will be added to existing transactions. One such expected change is the support for WS-Security and WS-Reliable Messaging as new options to web services transactions.

2740

## V.7 Web Services References

WS-I: <http://ws-i.org/>

WS-I Basic Profile 1.2: <http://ws-i.org/Profiles/BasicProfile-1.2-2010-11-09.html>

2745 WS-I Basic Profile 2.0: <http://ws-i.org/Profiles/BasicProfile-2.0-2010-11-09.html>

SOAP 1.2: <http://www.w3.org/TR/soap12-part0/>

WSDL 1.1 SOAP 1.2 binding: <http://www.w3.org/Submission/wsd11soap12/>

HL7 V3 Web Services Profile:

<http://www.hl7.org/v3ballot/html/infrastructure/transport/transport-wsprofiles.htm>

2750 WS-Addressing: <http://www.w3.org/TR/ws-addr-core>

WS-I Basic Security Profile 1.1: <http://www.ws-i.org/Profiles/BasicSecurityProfile-1.1.html>

WS-I Reliable Secure Profile: <http://www.ws-i.org/Profiles/ReliableSecureProfile-1.0-2010-11-09.html>

MTOM: <http://www.w3.org/TR/soap12-mtom/>

2755 XOP: <http://www.w3.org/TR/xop10/>

WS-Security 1.0: [http://www.oasis-open.org/committees/tc\\_home.php?wg\\_abbrev=wss#technical](http://www.oasis-open.org/committees/tc_home.php?wg_abbrev=wss#technical)

WS-Security 1.1: [http://www.oasis-open.org/committees/tc\\_home.php?wg\\_abbrev=wss#technical](http://www.oasis-open.org/committees/tc_home.php?wg_abbrev=wss#technical)

2760 WS-Secure Conversation: <http://docs.oasis-open.org/ws-sx/ws-secureconversation/v1.4/ws-secureconversation.html>

WS-Trust: <http://docs.oasis-open.org/ws-sx/ws-trust/v1.4/errata01/os/ws-trust-1.4-errata01-os-complete.html>

WS-Policy: <http://www.w3.org/TR/ws-policy/>

2765 WS-Reliable Messaging: <http://docs.oasis-open.org/ws-rx/wsrn/200702>

## V.8 Usage of MTOM/XOP

See Section V.9 for sample messages.

### V.8.1 Simple SOAP vs MTOM

2770 A simple SOAP message contains the SOAP xml as the message body. An MTOM-encoded message contains a MIME Multipart message with the SOAP xml as the body of one of the parts.

Unless a transaction specifies otherwise, Simple SOAP shall be used. Both the request and the response messages shall use the same encoding.

### V.8.2 Use of MTOM encoding

2775 Transactions making use of MTOM shall conform to <http://www.w3.org/TR/soap12-mtom> and <http://www.w3.org/TR/xop10/>.

Actors that create messages with `xsi:base64Binary` content may use XOP Optimization to reduce the size of the message. If there are multiple `xsi:base64Binary` content elements, the actor may optimize none, any or all of them at its discretion. Typically, small content will be left in the XML Infoset while larger content will be "optimized".

2780 Actors that receive MTOM messages shall be capable of accepting any content of type `xsi:base64Binary` whether it is contained in the XML Infoset or serialized as Optimized Content.

See the following sections of the XOP specification for more information:

- <https://www.w3.org/TR/2005/REC-xop10-20050125/#introduction> (Introduction)
- <https://www.w3.org/TR/2005/REC-xop10-20050125/#terminology> (Terminology)
- 2785 • [https://www.w3.org/TR/2005/REC-xop10-20050125/#creating\\_xop\\_packages](https://www.w3.org/TR/2005/REC-xop10-20050125/#creating_xop_packages) (Creating XOP Packages).



- [https://www.w3.org/TR/2005/REC-xop10-20050125/#interpreting\\_xop\\_packages](https://www.w3.org/TR/2005/REC-xop10-20050125/#interpreting_xop_packages) (Interpreting XOP Packages).

### V.8.3 Use of XOP Optimization (Informative)

2790 In order to optimize a specific piece of binary data:

- Create an additional MIME part in the enclosing MTOM message.
- Assign the new MIME part a Content-ID header containing a unique identifier surrounded by `<>` angle brackets.
- Place the Optimized Content in the body of the new MIME part.

2795 • Replace the Optimized Content with an `<xop:Include>` element. The `@href` attribute of the element is the string “cid:” followed by the Content-ID header of the corresponding MIME part (without the `<>` brackets)

Note that reconstruction of XOP-encoded messages must render them identical to the original in terms of the XML Infoset, in order to be able to calculate matching digital signatures (see [http://www.w3.org/TR/xop10/#xop\\_processing\\_model](http://www.w3.org/TR/xop10/#xop_processing_model)). As such, only canonical data may be XOP-optimized and XOP-optimized items should be reconstructed to canonical `xsi:base64Binary` form (see <http://www.w3.org/TR/xmlschema-2/#base64Binary> for a description of the canonical form).

2800

## V.9 Sample SOAP Messages

2805 Because there are so many different ways to construct SOAP messages, the samples in this section show the building blocks typically used for SOAP requests and their relative SOAP responses. A sample combining many of the building blocks is included in Section V.9.4.

Namespace declarations (see Table V.2.4-1) are omitted for brevity.

### V.9.1 Simple SOAP

2810

```
<?xml version='1.0' encoding='UTF-8'?>
<soap12:Envelope>
  <soap12:Header>
    <!-- SOAP Headers go here -->
  </soap12:Header>
  <soap12:Body>
    <!-- SOAP Body goes here -->
  </soap12:Body>
</soap12:Envelope>
```

2815

### V.9.2 SOAP Headers

2820 The sample headers show the WS-Addressing headers `<wsa:Action/>`, `<wsa:MessageID/>`, `<wsa:ReplyTo/>`, etc. These WS-Addressing headers are populated according to Appendix V: Web Services for IHE Transactions and according to the specific ITI transaction.

**V.9.2.1 Headers for Synchronous Request**

```

2825 <soap12:Header>
      <wsa:To>http://localhost:4040/axis2/services/test11966a</wsa:To>
      <wsa:MessageID>urn:uuid:76A2C3D9BCD3AECFF31217932910053</wsa:MessageID>
      <wsa:Action soap12:mustUnderstand="1">
        urn:ihe:iti:2007:ProvideAndRegisterDocumentSet-b
2830 </wsa:Action>
      <wsa:ReplyTo>
        <wsa:Address>
          http://www.w3.org/2005/08/addressing/anonymous
        </wsa:Address>
2835 </wsa:ReplyTo>
    </soap12:Header>

```

**V.9.2.2 Headers for Synchronous Response**

```

2840 <soap12:Header>
      <wsa:Action soap12:mustUnderstand="1">
        urn:ihe:iti:2007:ProvideAndRegisterDocumentSet-bResponse
      </wsa:Action>
      <wsa:RelatesTo>urn:uuid:6d296e90-e5dc-43d0-b455-7c1f3eb35d83</wsa:RelatesTo>
    </soap12:Header>

```

**V.9.2.3 Headers for Asynchronous Request**

```

2845 <soap12:Header>
      <wsa:Action soap12:mustUnderstand="1">
        urn:ihe:iti:2007:ProvideAndRegisterDocumentSet-b
      </wsa:Action>
      <wsa:MessageID>urn:uuid:6d296e90-e5dc-43d0-b455-7c1f3eb35d83</wsa:MessageID>
2850 <wsa:ReplyTo soap12:mustUnderstand="1">
        <wsa:Address>
          http://192.168.2.4:9080/XdsService/DocumentSourceReceiver.svc
        </wsa:Address>
      </wsa:ReplyTo>
2855 <wsa:To soap12:mustUnderstand="1">
        http://localhost:2647/XdsService/DocumentRepositoryReceiver.svc
      </wsa:To>
    </soap12:Header>

```

**V.9.2.4 Headers for Asynchronous Response**

```

2860 <soap12:Header>
      <wsa:Action soap12:mustUnderstand="1">
        urn:ihe:iti:2007:ProvideAndRegisterDocumentSet-bResponse
      </wsa:Action>
      <wsa:MessageID>urn:uuid:D6C21225-8E7B-454E-9750-821622C099DB</wsa:MessageID>
2865 <wsa:RelatesTo>urn:uuid:6d296e90-e5dc-43d0-b455-7c1f3eb35d83</wsa:RelatesTo>
      <wsa:To soap12:mustUnderstand="1">
        http://localhost:2647/XdsService/DocumentSourceReceiver.svc
      </wsa:To>
    </soap12:Header>

```

**V.9.3 MTOM/XOP**

2870 HTTP headers are included in this sample to reflect the HTTP Binding included in the MTOM specification.

**V.9.3.1 No XOP Optimized Content**

```
2875 POST /axis2/services/repository HTTP/1.1
Content-Type: multipart/related; boundary=MIMEBoundaryurn_uuid_76A2C3D9BCD3AECFF31217932910180;
  type="application/xop+xml"; start="<0.urn:uuid:76A2C3D9BCD3AECFF31217932910181@apache.org>";
  start-info="application/soap+xml"; action="urn:ihe:iti:2007:ProvideAndRegisterDocumentSet-b"
2880 User-Agent: Axis2
Host: localhost:4040
Content-Length: 4567

--MIMEBoundaryurn_uuid_76A2C3D9BCD3AECFF31217932910180
2885 Content-Type: application/xop+xml; charset=UTF-8; type="application/soap+xml"
Content-Transfer-Encoding: binary
Content-ID: <0.urn:uuid:76A2C3D9BCD3AECFF31217932910181@apache.org>

<!-- The soap12:Envelope has the same content as Simple SOAP -->
2890 <?xml version='1.0' encoding='UTF-8'?>
<soap12:Envelope>
  <soap12:Header>
    <!-- SOAP Headers go here -->
  </soap12:Header>
2895 <soap12:Body>
  <!-- Other parts of SOAP body omitted -->

  <xds:Document id="id1">
    <!-- Example of un-optimized content. NOTE: The content is shown indented for
2900 whitespace readability. For XOP optimized content to be allowed, however, no
    is permitted before, inline or after the content. -->
    SGVyZSBpcyB0aGUgZG9jdW1lbnQgY29udGVudA==
  </xds:Document>

2905 </soap12:Body>
</soap12:Envelope>

--MIMEBoundaryurn_uuid_76A2C3D9BCD3AECFF31217932910180
```

2910

2915

2920

**V.9.3.2 XOP Optimized Content**

```

2925 POST /axis2/services/repository HTTP/1.1
Content-Type: multipart/related; boundary=MIMEBoundaryurn_uuid_76A2C3D9BCD3AECFF31217932910180;
  type="application/xop+xml"; start="<0.urn:uuid76A2C3D9BCD3AECFF31217932910181@apache.org>";
  start-info="application/soap+xml"; action="urn:ihe:iti:2007:ProvideAndRegisterDocumentSet-b"
User-Agent: Axis2
2930 Host: localhost:4040
Content-Length: 4567

--MIMEBoundaryurn_uuid_76A2C3D9BCD3AECFF31217932910180
Content-Type: application/xop+xml; charset=UTF-8; type="application/soap+xml"
Content-Transfer-Encoding: binary
2935 Content-ID: <0.urn:uuid:76A2C3D9BCD3AECFF31217932910181@apache.org>

<!-- The soap12:Envelope has the same content as Simple SOAP, except for the optimized
      content -->
2940 <?xml version='1.0' encoding='UTF-8'?>
<soap12:Envelope>
  <soap12:Header>
    <!-- SOAP Headers go here -->
    </soap12:Header>
2945 <soap12:Body>
  <!-- Other parts of SOAP body omitted -->

    <xds:Document id="id1">
      <!-- Example of XOP optimized content. NOTE: xop:Include is shown indented for
            readability. In practice, no whitespace is allowed before or
            after the element. -->
2950 <xop:Include href="cid:1.urn:uuid:76A2C3D9BCD3AECFF31217932910181@apache.org">
    </xds:Document>

  </soap12:Body>
2955 </soap12:Envelope>

--MIMEBoundaryurn_uuid_76A2C3D9BCD3AECFF31217932910180
Content-Type: text/plain; charset=UTF-8"
Content-Transfer-Encoding: binary
2960 Content-ID: <1.urn:uuid:76A2C3D9BCD3AECFF31217932910181@apache.org>

Here is the document content
--MIMEBoundaryurn_uuid_76A2C3D9BCD3AECFF31217932910180--

```

2965

2970

2975

**V.9.4 Full Sample**

This sample combines several of the building blocks from the previous sections to show a Synchronous Request that uses MTOM/XOP with optimized content.

```

2980 POST /axis2/services/repository HTTP/1.1
Content-Type: multipart/related; boundary=MIMEBoundaryurn_uuid_76A2C3D9BCD3AECFF31217932910180;
  type="application/xop+xml"; start="<0.urn:uuid:76A2C3D9BCD3AECFF31217932910181@apache.org>";
  start-info="application/soap+xml"; action="urn:ihe:iti:2007:ProvideAndRegisterDocumentSet-b"
2985 User-Agent: Axis2
Host: localhost:4040
Content-Length: 4567

--MIMEBoundaryurn_uuid_76A2C3D9BCD3AECFF31217932910180
2990 Content-Type: application/xop+xml; charset=UTF-8; type="application/soap+xml"
Content-Transfer-Encoding: binary
Content-ID: <0.urn:uuid:76A2C3D9BCD3AECFF31217932910181@apache.org>

<?xml version='1.0' encoding='UTF-8'?>
2995 <soap12:Envelope>
  <soap12:Header>
    <wsa:To>http://localhost:4040/axis2/services/test11966a</wsa:To>
    <wsa:MessageID>urn:uuid:76A2C3D9BCD3AECFF31217932910053</wsa:MessageID>
    <wsa:Action soap12:mustUnderstand="1">
3000       urn:ihe:iti:2007:ProvideAndRegisterDocumentSet-b
    </wsa:Action>
    <wsa:ReplyTo>
      <wsa:Address>
3005         http://www.w3.org/2005/08/addressing/anonymous
      </wsa:Address>
    </wsa:ReplyTo>
  </soap12:Header>
  <soap12:Body>
    <!-- Other parts of SOAP body omitted -->
3010     <xds:Document id="id1">
      <xop:Include href="cid:1.urn:uuid:76A2C3D9BCD3AECFF31217932910181@apache.org">
3015     </xds:Document>
    </soap12:Body>
  </soap12:Envelope>

--MIMEBoundaryurn_uuid_76A2C3D9BCD3AECFF31217932910180
Content-Type: text/plain; charset=UTF-8"
Content-Transfer-Encoding: binary
3020 Content-ID: <1.urn:uuid:76A2C3D9BCD3AECFF31217932910181@apache.org>

Here is the document content
--MIMEBoundaryurn_uuid_76A2C3D9BCD3AECFF31217932910180--

```

## Appendix W: Implementation Material

3025 Implementation material is non-normative and includes schema, examples, WSDL, FHIR<sup>®11</sup> conformance resources, and more.

Implementation material for some profiles can be found on the [IHE Google Drive](#).

3030 FHIR conformance resources (e.g., StructureDefinition, CapabilityStatement, ValueSet, etc) for some IHE profiles can be found on the IHE-controlled “fhir” GitHub repository found at <https://github.com/IHE/fhir>.

## Appendix X: Basic Unstructured Workflow Definition Example

This appendix contains a Workflow Definition example that is intended to be used in conjunction with XDW Profile.

### 3035 X.1 Workflow definition identifier

Basic Unstructured Workflow is a very simple workflow in which a group of physicians/organizations acts on the same patient in an a priori unpredictable way.

This workflow is performed to allow the continuity of care for a patient in a generic and flexible way.

3040 We expect actual deployment to modify this example when developing basic workflows. It has two simple types of Tasks: the first one is useful for recording and sharing single user actions (“*I did this task*”) and the second one used to request that a task be performed by another organization and reporting its completion (“*please do this, I did it*”).

3045 Any specific workflow can include any combination of these two types of tasks. This example shows no dependencies among the tasks that are explicitly managed.

The catalog of task that maybe used in this workflow definition is not specified by this profile, and remains to be agreed in the affinity domain where the workflow is been deployed. This definition will result in a list of names and codes for any potential task.

### X.2 Workflow definition identifier

3050 The workflow definition identifier shall be inserted into the workflowDefinitionReference element of the Workflow Document.

| Workflow Definition name    | workflowDefinitionReference                              |
|-----------------------------|----------------------------------------------------------|
| Basic Unstructured Workflow | An “urn:oid” reference to a Workflow definition Document |

---

<sup>11</sup> is the registered trademark of Health Level Seven International and the use does not constitute endorsement by HL7.

### X.3 Workflow opening and closing

3055 The workflow should be opened by a physician or an Organization that participates in the workflow (e.g., continuity of care process). Any participant may choose to close the workflow.

### X.4 Tasks descriptions

#### X.4.1 Task type “born completed”

3060 Tasks of the type “born completed” are used by any workflow participant when the workflow is open or at any later point in time. This type is used for a workflow in which a participant want to share some actions perform in his enterprise on the patient. Typical examples can be a visit, or an emergency admission, or a patient self-monitoring event.

| Task attributes     | Rules for the task “born completed”                   |
|---------------------|-------------------------------------------------------|
| Task dependencies   | none                                                  |
| States allowed      | COMPLETED                                             |
| States transactions | None                                                  |
| input               | Zero or more clinical document of unconstrained types |
| output              | Zero or more clinical document of unconstrained types |
| owner               | every physician/organization                          |
| owner changes       | No                                                    |
| <taskEvent>         | Only one                                              |

#### X.4.2 Task type “two states task”

3065 This type of task is used by any workflow participant when the workflow is open or at any later point in time. This task type is used for a workflow in which a participant wants to share some actions performed in his enterprise on the patient. Typical examples can be a visit, or an emergency admission, or a patient self-monitoring event.

3070

| Task attributes     | Rules for the task “two states task”                                                                                                                                                                                                                                |
|---------------------|---------------------------------------------------------------------------------------------------------------------------------------------------------------------------------------------------------------------------------------------------------------------|
| Task dependencies   | None                                                                                                                                                                                                                                                                |
| States allowed      | CREATED<br>COMPLETED                                                                                                                                                                                                                                                |
| States transactions | When a workflow participant request that this task be performed by another workflow participant he places the task in a Workflow Document with CREATED status (no owner). When the requested task is performed by a participant the task status shall be COMPLETED. |
| input               | Zero or more clinical document of unconstrained types (e.g., eReferral Document, ePrescription)                                                                                                                                                                     |
| output              | Zero or more clinical document of unconstrained types (e.g., reports, radiological images, advice documents, dispensation documents)                                                                                                                                |
| owner               | any physician/organization that process this task in CREATED state                                                                                                                                                                                                  |

| Task attributes       | Rules for the task “two states task” |
|-----------------------|--------------------------------------|
| changes of task owner | Allowed                              |
| <taskEvent>           | At least two                         |



## GLOSSARY

IHE Glossary terms are maintained via the [Standards Knowledge Management Tool](#) (SKMT).

3075 SKMT contains IHE Glossary Terms from Final Text and Trial Implementation IHE profiles. Terms from Public Comment profiles are added once the profile is published for Trial Implementation.

The current published version of the IHE Glossary ([Appendix D](#) to the *IHE Technical Frameworks General Introduction*) contains IHE Glossary terms as of the publication date of the document. Always refer to the [SKMT](#) for the most up-to-date list of IHE Glossary terms.

3080 Further information about SKMT can be found on the IHE Wiki [here](#).